



02/2015 S380GB151500
Our policy of constant technological upgrading means that technical specifications may be subject to change without prior notice.



S380TRC |

The exclusivity of innovation

Sede Legale ed Amministrativa / Headquarters
CEFLA s.c.
Via Selice Prov.le, 23/a
40026 Imola (BO) - Italy
Tel. +39 0542 653111
Fax +39 0542 653344



Produttore / Manufacturer
Cefla Dental Group
Via Bicocca, 14/C - 40026 Imola (BO) - Italy
Tel. +39 0542 653441 - Fax +39 0542 653601
www.sternweber.com
sternweber@sternweber.com



INNOVATION IS POWER



**HEALTH FACILITY
MANAGER**

"Stern Weber just keeps on getting better. That's why it's the benchmark brand in the Dentistry Department".



ENDODONTICS SPECIALIST

"First-rate materials, user-friendly controls, all-round hygiene safeguards. Stern Weber gives me everything. Workplace safety at all times."



IMPLANTOLOGIST

"Cutting-edge instruments, perfect control and precise settings plus a patient chair that really makes the difference. For my specialisation, Stern Weber is the very best."

Evolution aims at perfection, finest details and rigorous constant improvement. Stern Weber's DNA is based on the wonders of technology, on enthusiasm for innovation, on the strength of genuine novelty. Rigour and precision are the key aspects of each new product, and the shapes of new design infuse such products with life. We believe in flexible working, in the perfection of true talent, in the importance of concrete steps being made towards true progress. We foresee the future today to guarantee a more innovative tomorrow.

INNOVATION ZONE

The strength of an innovative space lies with the solidity of rigour and the precision of flexibility. The desire to constantly improve and pursue technological progress creates a vital working space that is in perfect harmony with your operating style, because it is modelled on your work. We are not looking for mere sterile development, but for the perfect way of working, of moving, of thinking. Your ability acts as our guide, and our technology is your instrument. The new S380TRC is the perfect balance of rigour and technological innovation.











Slim seat shaping

A compact base and a specially shaped chair enable the operator to get as close as possible to the working area. The patient chair features 190 kg lift capacity and Trendelenburg movement.

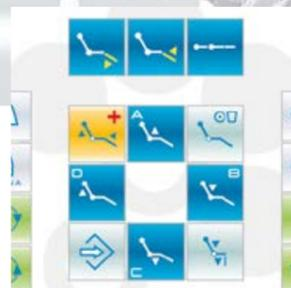

Patient chair controls

The keys on the control panel control all positions including that of the patient table for surgery.



Articulated leg rest

Even with the chair in the lowered position, the leg rest, which operates independently, may remain in the extended position.

Exclusive innovation

S380TRC boasts a unique chair full of features suited to the operating style of those looking for innovative exclusivity. Synchronized backrest and leg rest movements, powered retractable footrest: each function is designed to offer outstanding comfort in every position. Each movement is controlled by a touch control panel. The programme can memorize up to 4 personalized working positions for each operator. The patient entry/exit position and rinse position may also be personalized; the software controls two positions, namely the patient table position for surgery and the Trendelenburg position.



When the dentist's module is positioned on the assistant's side, use of the instruments does not impede the dentist's work.



Transform the workplace

The versatility of the chair provides plenty of scope for transforming the surgery into a workspace that is functionally and ergonomically suited to the requirements of individual treatment plans.

Chair rotation may be completed via the optional function that allows the module to be positioned on the assistant's side.



When the powered rotation brings the chair into entry position, the surrounding area is devoid of all obstacles. Everything is designed to optimise patient comfort and to accommodate the patient as serenely as possible.



The seated position is free of all surrounding obstacles, enabling the dentist to perform extractions with greater ease.



Fostering communication

The rotation of the chair in a seated position makes it easier for patients to get on and off the chair. When discussing the clinical situation, excellent dental unit ergonomics allow staff to dialogue effectively with patients and ensure they spend less time in the lying position during treatment. Ideal for all forms of dental treatment, the seated position may be regulated to all heights, permitting the natural occlusion between the two arches.



Personalised parameters
The control panel can also be used to personalise parameters for up to four different users.



USB Port
It is also possible, by using the fourth profile (Guest profile) to save a set of personalized parameters on a USB flash drive. This provides a consultant with constant access to his/her own chosen settings even if such have not been stored in the control panel's memory.



Precision control
The precision handling of instruments and incorporated systems enables dentists to fully express their potential, and to constantly develop their professional skills.

Share the innovation

Right on the cutting edge of digital technology, the powerful microprocessor handles all the functions and systems on the integrated treatment centre, which the dentist pilots via the Full Touch control panel. A few intuitive movements enable the dentist to regulate and personalize working parameters through the 5.7" tempered glass touch screen.

Designed to offer a high degree of personalization, the software permits connections with incorporated Stern Weber devices, including multimedia and radiological instruments. By means of an Ethernet connection access is provided to a local network without having to use an external PC. The accelerometer on the instrument control panel also allows the screen to be positioned horizontally.

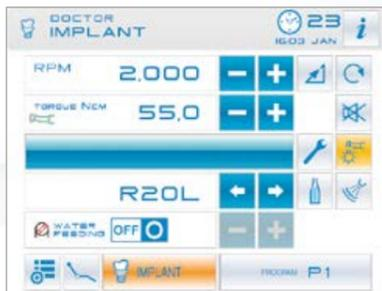

In surgery mode, the i-XS4 micromotor electronic controls include speed, torque, plus flow rate/operation of the peristaltic pump.



In endodontics mode, the Full Touch software sets combined torque/speed values according to the selected file by drawing on data in preloaded library files. An integrated apex locator is also available with display on the control panel screen.



Brushless micromotor i-XS4

Light, with a removable LED element and a mechanism that prevents the cooling air flow from reaching the operating area, the i-XS4 offers outstanding performance. By limiting speed to 40,000 rpm, torque values as high as 5.3 Ncm – or up to 70 Ncm with a suitable contra-angle – can be attained. Where used for implantology, personalised settings are available for execution of the guide hole, the drilling stages and implant placement. Speed range from 100 to 40,000 rpm.



Peristaltic pump

Integrated on the dentist's module, the peristaltic pump lets the i-XS4 micromotor be used for oral surgery operations.

Achieve your full potential

Regardless of the type of operation, from conservative dentistry to oral surgery, the dentist is required to operate with incredible precision. Thanks to the Full Touch instrument control panel, comprehensive control of both parameters and the peristaltic pump bring out the full potential of the brushless micromotor when practising surgery. A database of certified contra-angles is provided in the software, as is a selection of generic ratios. Parameter control and data display are optimised thanks to fast navigation and user-friendly graphics.



SC Scalers
Indicated for supragingival prophylaxis tasks of the periodontal type and for the preparation of small cavities and in endodontic root canal cleaning techniques.



Capacitive sensor
The capacitive sensor, inserted inside the handle underneath the instrument control panel, is used to deactivate the pneumatic brake and then accurately lock the dentist's module in position.



Left-side control panel
The optional kit with arm performing movements on the assistant's side comprises an additional left-side handle with release sensor and Full Touch control panel relocatable on the left side of the dentist's module on the Continental version.



Sixth instrument
It's also possible to complete the dentist's module with an optional sixth instrument: camera or T-LED light. The option is, only on the version that allows the arm to be positioned on the assistant's side, precluded so the control panel can be repositioned.

Experience unparalleled technological evolution

The Stern Weber instruments, which were designed together with the electronics that control them, guarantee excellent performance and offer dentists a genuine opportunity to personalize their dental units. Dentists can also, in addition to setting personalised programme, set numerous work parameters: power/speed, spray, foot control mode and optic fibre intensity. All settings are made using the advanced Full Touch control panel.

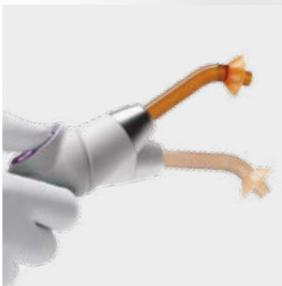

T-LED
 Patented dual-ergonomics curing light with 6 polymerisation and bonding programmes. Each of the 6 programmes has been fine-tuned to prevent the phenomena of compound shrinkage (anomalous hardening and volume loss).



Memory Foam
 Memory Foam padding supports patients correctly throughout the entire treatment session, resulting in enhanced comfort and relaxation.

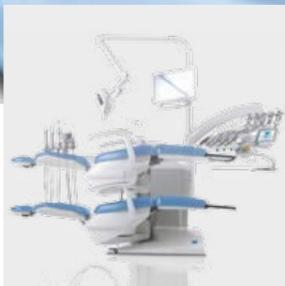

Vertical travel
 As well as the chair's powered rotation and its capacity to lift up to 190 kg, vertical travel ranges from 39 to 79 cm from floor level.



Assistant's module
 The 3-holder assistant's module, fitted on the vertically adjustable articulated arm, can be positioned at a height that best suits medical staff. An optional add-on unit with 2 instrument holders for camera and T-LED light is also available.

Discover the value of wellbeing

The Stern Weber philosophy places great emphasis on patient wellbeing and the operating comfort of staff, so as to create a pleasant environment where innovation improves your professional working experience.

The anatomical headrest can be regulated with one hand, by releasing the pneumatic brake using the button on its underside. Positioning is precise thanks to the orbital and vertical movement along the support rod.



Venus Plus - L LED

- Light intensity from 3,000 to 50,000 Lux
- Colour temperature 5,000 K
- Low-thermal emission LED light sources
- Silent running because there is no forced ventilation
- LEDs guaranteed to work 50,000 hours

Hermetically sealed front screen. This makes external cleaning easier and stops any dust or spray fluid getting inside the dish.



Power Pedal foot control



Multi-function foot control



Pressure-operated foot control

The pedal foot control comes in three different ergonomic versions, two of which are available in a wireless configuration to maximise freedom of movement during treatment. With the instrument extracted micromotor rotation can be inverted and the operating light switched on. Moreover, the peristaltic pump may be opened and closed in surgery mode and the micro-motor settings changed.

Making room for your needs

Creating innovative equipment and devices that meet real needs is the best way of building a relationship that facilitates all aspects of your professional life. Stern Weber provides an extensive product range, ergonomic solutions that pave the way for ground-breaking technology and high-performance patented instruments. Stern Weber supplies complete, tailor-made integrated treatment centres.

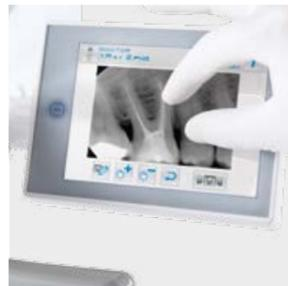
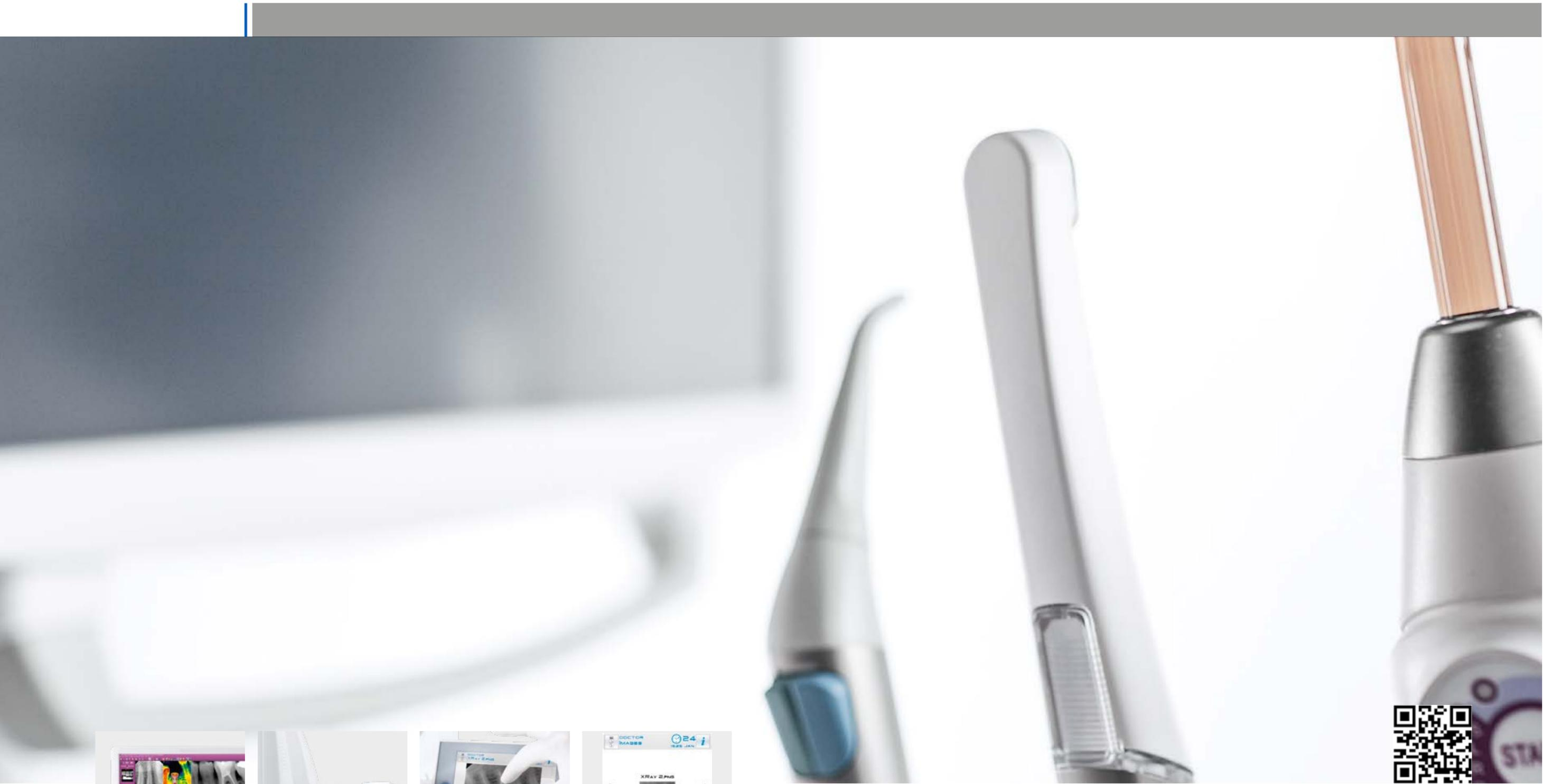

19" LED Monitor

CE 93/42 certified, the 16:9 monitor comes complete with a lead for connection to the PC. LED light sources ensure outstanding contrast and brightness. For the touch-screen version the optional double-articulated arm is recommended to move the screen in closer or further away from the operating zone. The screen is also tilt-adjustable.

Full Touch

Even without an incorporated monitor, the panel enables you to view high-resolution images and to change settings such as brightness, contrast and size.

X-ray imaging

The X-ray images obtained using the digital sensor may be managed and saved on the panel or may be transferred outside the dental unit via a USB connection.

Multimedia smoothes the way

Immediacy is of fundamental importance: quicker diagnosis, sharing images with patients and convincing them to have the right treatment are all vital. Perfect integration is the key to everything, and the latest version of the Stern Weber multimedia system significantly boosts the potential of diagnostics.

High-definition camera, high-frequency X-ray unit, the very latest X-ray sensor – all connected and controlled via the Full Touch control panel. The dentist may control images directly on the touch panel, on a medical monitor or on an external PC.

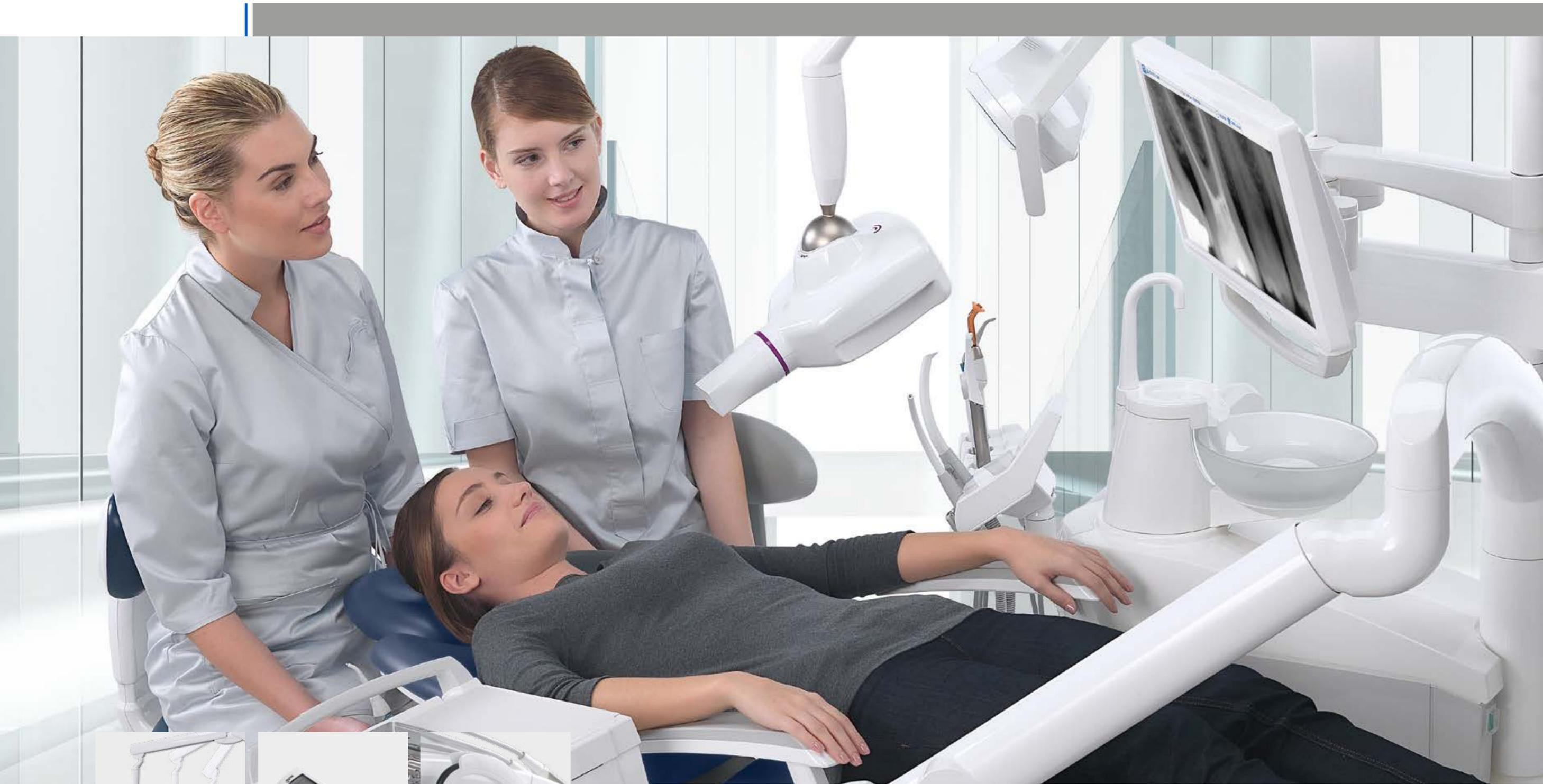

RXDC HyperSphere+

This DC X-ray unit with integrated 30 cm collimation provides pin-sharp images thanks to a focal spot of just 0.4 mm. A spherical ball-joint and a lock/release mechanism activated by 2 touch-sensitive areas on the tube head ensure that positioning is both fast and precise. The handheld wireless control device features 4 keys to adjust exposure and another key to take the X-ray. The RXDC automatically calculates the correct exposure on the basis of the selected anatomic area.

Zen-X

Digital sensor with three-layer technology and CMOS receptor available in 2 sizes. Built to last and featuring rounded edges, the sensor can be positioned in the patient's mouth easily and comfortably. Simple to remove, it can be transferred onto other device-compatible machines.

Speeding up diagnostics

The integrated X-ray system lies at the forefront of technological development and considerably helps improve the surgery's efficiency. Controlled from a simple wireless handheld computer, the DC X-ray unit is designed specifically for digital radiology. Together with the sensor applied to the dentist's module and to the 19" LED Monitor, it constitutes an advanced X-ray diagnosis system that does not require any installation points in the surgery. It enables you to always remain at your patient's side while having ready access to solutions to your actual needs.

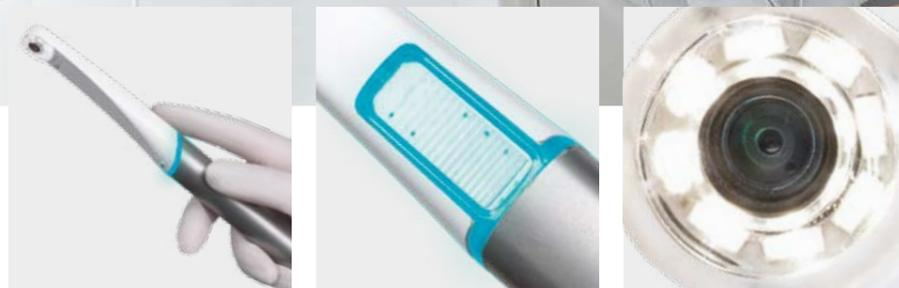

C-U2. High definition camera

A digital camera with HD sensor and glass optics, the C-U2 provides high-resolution images directly to the panel, or in full-screen format on the 19" LED monitor. Connected to the dental unit's electronic circuit, it provides extra-oral and intra-oral images. The backlit multi-function button enables the operator to freeze frame images and to subsequently store them. The slim design of the handpiece, with its 9.5 mm tip, enables the operator to reach the distal areas. Thanks to the partial retroflex and the 90° angle view, exploration of the oral cavity is simple and complete. The optical system with 7 glass lenses and a F/8 aperture guarantees excellent brightness and an extensive depth of field (min. 5 mm max. 70 mm) with any need for manual focussing.

The additional benefits of HD

The very latest digital multimedia is to be found in Stern Weber's new system, with its sophisticated HD camera taking image communications to a higher level. The system's clear benefits are enhanced by its ergonomic design and innovative, backlit capacitive key. It is much easier to appreciate results via the transparency of an image. Patient's loyalty is generated through clear, reassuring communication with the dentist.

The automatic continuous sanitisation system **W.H.E.** also guarantees air gap separation from the mains water in compliance with European standards; the system is also DVGW-certified. A combination of **Peroxy Ag+** (H₂O₂) disinfectant and the intense action of the **BIOSTER** system ensures the highest possible hygiene of irrigation liquids and protects the water circuit against the onset and multiplication of water-borne contaminants such as Legionella.



BIOSTER
The **BIOSTER** intensive disinfection system performs its operations when the dentist has completed his task. It carries out automatic cycles of disinfection of the spray water circuits and guarantees total protection against the transmission of micro-organisms in the dental unit. The **LW.F.C.** device, incorporated in the **BIOSTER** system or available separately, ensures water circuits are kept clean after a period of machine idleness.



SANASPRAY
Distilled water can be used by bypassing the mains water. To carry out rapid circuit sanitisation a second tank is available. Given its tried and tested effectiveness, the use of **Peroxy Ag+** disinfectant is recommended.



A.C.V.S.
Automatic system that carries out suction system sanitisation cycles between one patient and another.



Automatic Chip Air
This system, featured as standard, automatically emits an air jet when you stop using dynamic instruments so as to clean any residual liquids or solids from the handpiece.

Completing your protected treatment centre

It has been scientifically proven that the efficiency of the Stern Weber hygiene systems satisfies a basic requirement of the dentist's professional operations. It is also the perfect way of guaranteeing a serene working environment and ensuring further respect between colleagues and patients. Complete with all active systems, and fully controlled by the control panel's processor, the dental unit is transformed into a protected treatment centre.

Navigating through the integrated systems menu and setting the chosen parameters is both simple and fast. The best way of ensuring constant control of the dental unit's hygienic conditions.



Easy access
The unit body covers the entire side of the unit. Makes access for maintenance tasks easier.



Disposable covers
Disposable instrument control panel covers. To clean without interfering with controls, deactivate the touch screen function on the Full Touch unit by pressing the dedicated key.



Removable upholstery
Surfaces coated with polyurethane paint or made of techno-polymers highly resistant to chemical disinfectants. Upholstery is easily sanitised.



Instrument mats
The instrument holder panel is removable and the soft, silicon instrument mat is both removable and autoclavable.



Double filters
The double suction filters fit flush with the unit body. Extensive filtration surface area reduces emptying frequency. Automatic and independent selection of cannulae is available.



Cannula roller guide
Holder guides provide support during extraction and replacement of the suction cannulae. The roller housing can easily be removed for disinfection and cleaning purposes.

Choose advanced protection

Maximum protection for you, your colleagues and your patients, is one of the top priorities of Stern Weber when designing its dental units. The pursuit of effective, functional solutions is something that we deal with from all points of view. The passive hygiene system both inside and outside the dental unit is constituted by detachable elements, easily-cleaned surfaces, controls transferred to the pedal, and autoclavable materials. Design stems from an approach aimed at completely eliminating contamination risks in the surgery.

S380TRC	INTERNATIONAL	CONTINENTAL
---------	---------------	-------------

HYGIENE SYSTEMS

BIOSTER	*	*
A.C.V.S.	*	*
SANASPRAY	*	*
W.H.E.	*	*
I.W.F.C.	*	*

DENTIST'S MODULE

LEFT SIDE PACK	-	*
Full Touch display	●	●
Micromotor i-XS4 with f.o. (100 - 40,000 rpm)	●	●
Peristaltic pump module	*	*
6-way syringe with f.o.	*	*
Sixth instrument	*	*
Panoramic X-ray viewer	*	-
Integrated sensor	*	*
Integrated Apex Locator	*	*

UNIT BODY

Glass cuspidor bowl	●	●
Ceramic cuspidor bowl	*	*
Cuspidor bowl drive system	●	●
Water-to-cup heater	●	●
Spray heating	*	*
Independent cannulae selection	●	●
Suction stop device on chair base	●	●
Multimedia applications wiring	●	●
Transthoracic tray holder	*	-
Dentist's module tray holder	*	●
Assistant's tray holder	*	*
Venus Plus-L LED operating light	●	●

PATIENT CHAIR

Atlaxis headrest	●	●
Right armrest	●	●
Left armrest	●	●
Child's cushion	*	*
Multi-function foot-control	●	●
Pressure-operated foot control	*	*
Power Pedal Foot Control	*	*
Multi-function foot-control (wireless)	*	*
Pressure-operated foot control (wireless)	*	*

● as standard * optional - unavailable

CONTINENTAL

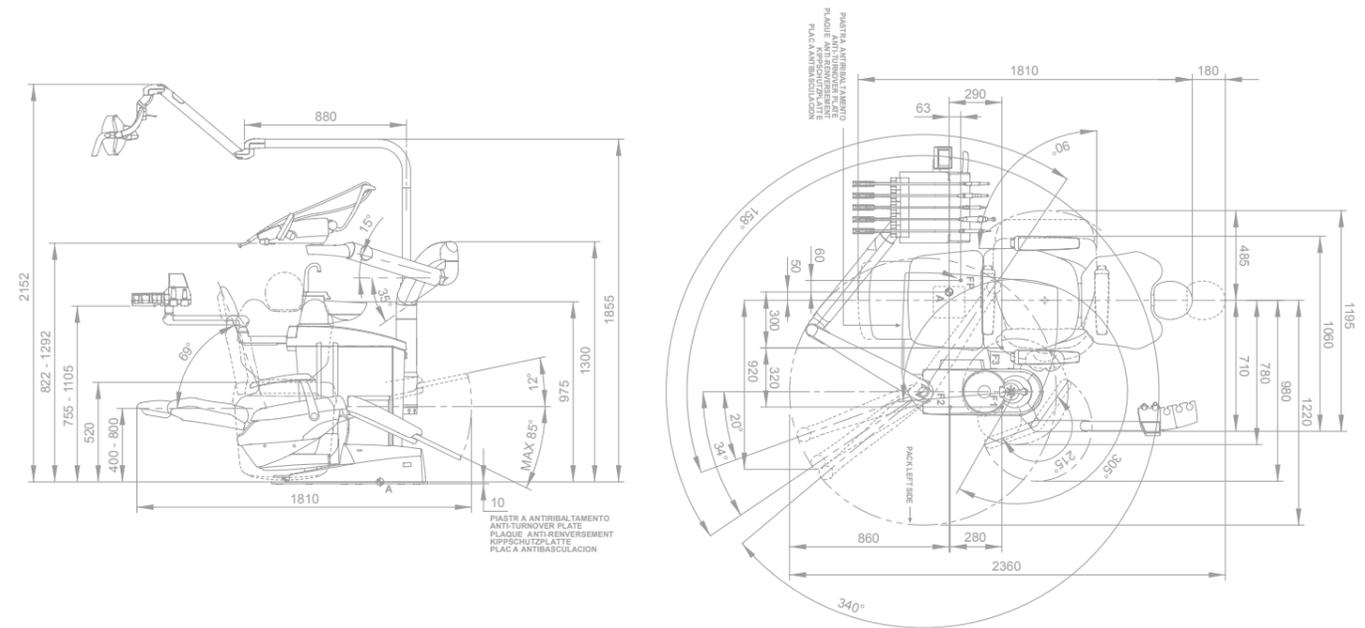

INTERNATIONAL

