

*Dental Instruments Catalogue*

**786**



Articulator	108
Amalgam Carriers	88
Amalgam Carvers	66 - 67
Blowers, Napkin & Film Holder	90
Bone Rongeurs	20
Crown Instruments & Removers & Plaster Cutting Pliers	92 - 94
Cavity Preparation Instruments	68
Chisels and Gouges	51
Excavators	69 - 71
<b>Endodontic Instruments</b>	
Explorers, Probes	58 - 61
<b>Forceps</b>	
English Pattern Forceps	1 - 11
Root Fragment Forceps	12
For Children with spring	13
American Pattern Forceps	14 - 18
Root Splinter Forceps	19
Haemostatic Forceps	38 - 39
Sponge & Dressing Forceps	40
Sterilizing Forceps	43
Root Splinter Forceps	19
Filling Instruments Plastic Filling Instrument	62 - 66
Gracey Curettes & Scalers	75 - 81
<b>Handles</b>	
Handles For Mouth Mirrors	55
Scalpel Handle	56
Handle Reference Guide	57
Matrix Retainers	91
Needle Holder	41 - 42
Orthodontic Instruments	33
Pliers for Orthodontics & Prosthetics	31-106-107
Periodontia Instruments	76
Pliers Tissue, Cotton & Dressing	53 - 54
Root Elevators	21 - 27
Retractors Raspatories & Elevators	44 - 50
Rubber Dam Instruments	52
Rubber Dam Clamps	105
Scissors	33 - 37
<b>Spatula</b>	
Cement Spatulas	82
Spatula (Plaster & Alginate)	87
<b>Syringes</b>	
Cartridge & Water Syringe	89 - 90
Towel Clamps & Skin Hook	44
Impression Trays, Holloware	95 - 104
Wax & Modelling Carvers	83 - 85
Wax Knives	86

Extracting Forceps  
English Pattern



786-101  
Fig.1  
Upper centrals  
& canines



786-102  
Fig.2  
Upper laterals  
& bicuspids



786-103  
Fig.3  
Upper incisors  
& canines



786-104  
Fig.4  
Lower incisors  
& Canines



786-105  
Fig.7  
Upper primolars



786-106  
Fig.8  
Lower primolars



786-107  
Fig.13  
Lower primolars

# Extracting Forceps English Pattern



786-108  
Fig. 17  
Right upper molars



786-109  
Fig. 18  
Left upper molars

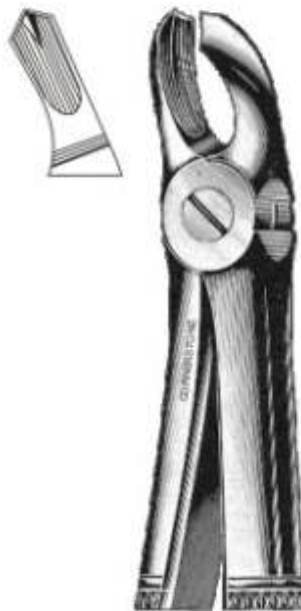

786-110  
Fig. 18A  
Upper molars



786-111  
Fig. 19  
Upper wisdoms

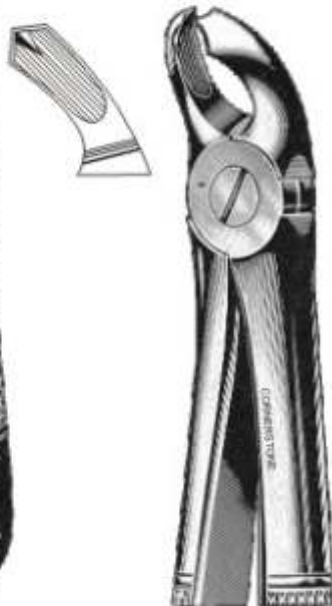

786-112  
Fig. 20  
Lower wisdoms



786-113  
Fig. 21  
Lower molars



786-114  
Fig. 22  
Lower molars  
Hawk's bill

Extracting Forceps  
 English Pattern



786-115  
Fig.23  
Right lower molars



786-116  
Fig.24  
Left lower molars



786-117  
Fig.29  
Upper roots  
& incisors



786-118  
Fig.29N  
Roots of upper  
incisors



786-119  
Fig.30  
Upper roots &  
incisors

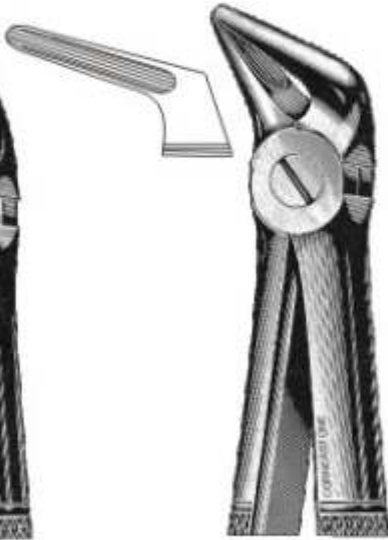

786-120  
Fig.31  
Lower roots



786-121  
Fig.32  
Lower molars



# Extracting Forceps English Pattern

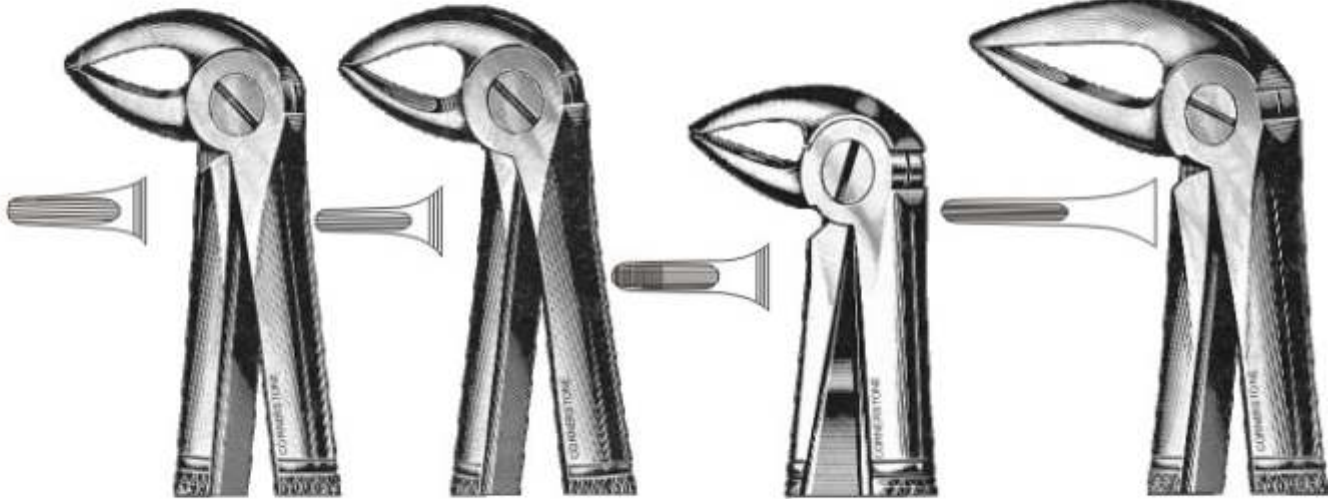

786-122  
Fig.33  
Lower roots

786-123  
Fig.33A  
Lower roots

786-124  
Fig.33C  
Lower roots

786-125  
Fig.33M  
Lower roots  
with long beak

04

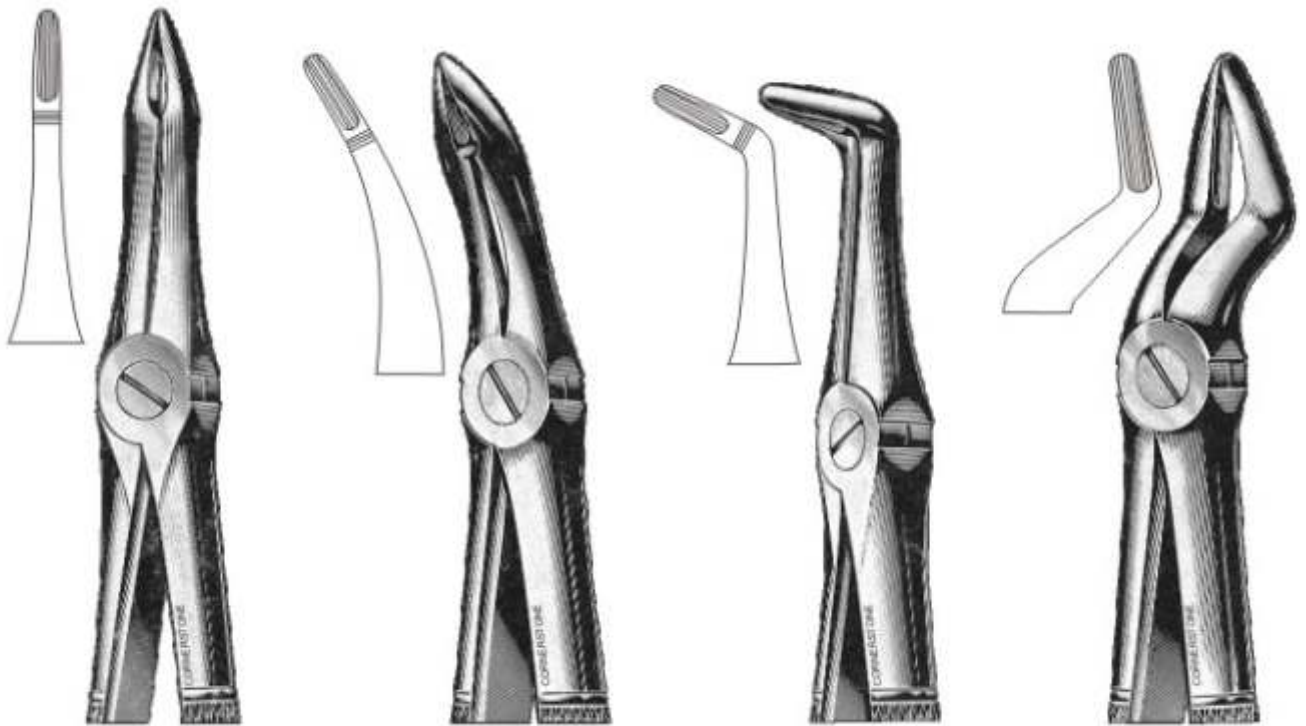

786-126  
Fig.41  
Upper roots

786-127  
Fig.44  
Upper roots

786-128  
Fig.45  
Lower roots

786-129  
Fig.51  
Upper roots

Extracting Forceps  
English Pattern

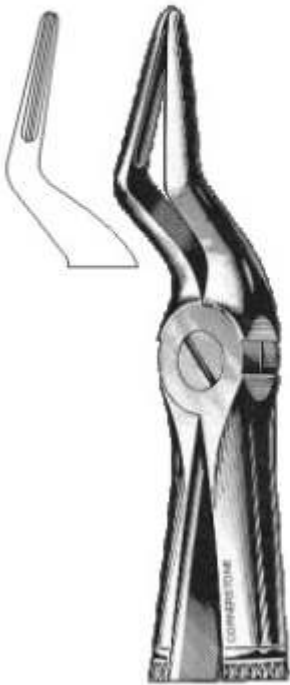

786-130  
Fig.51A  
Upper roots  
narrow beak

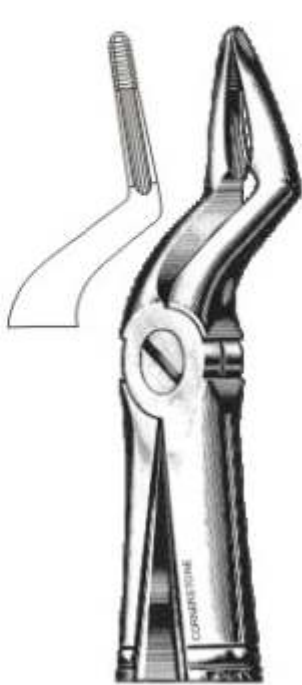

786-131  
Fig.51C  
Upper roots



786-132  
Fig.52  
Upper roots & canines  
with wider beak

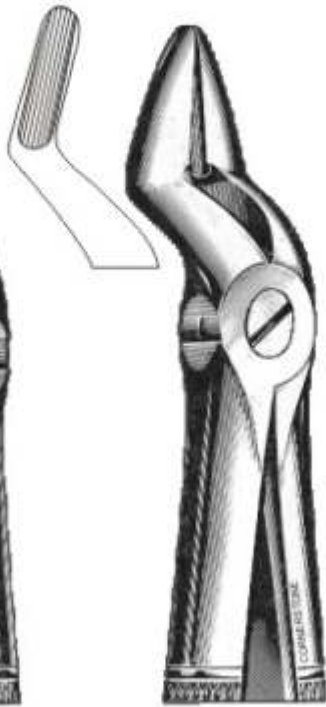

786-133  
Fig.52A  
Upper teeth &  
resection



786-134  
Fig.55  
Separating upper  
molars roots



786-135  
Fig.56  
Separating lower  
molars roots



786-136  
Fig.67  
Upper wisdoms



786-137  
Fig.67A  
Upper wisdoms

Extracting Forceps  
English Pattern



786-138  
Fig. 68  
Lower roots

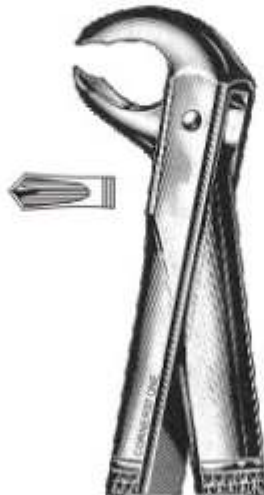

786-139  
Fig. 73  
Lower molars  
(Hawk's bill)

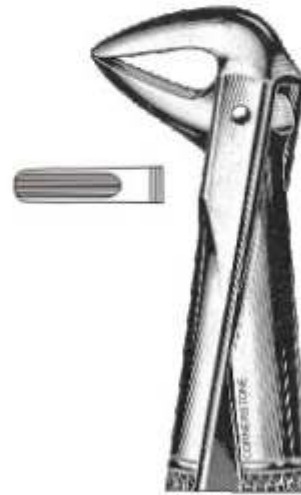

786-140  
Fig. 74  
Lower incisors  
& roots



786-141  
Fig. 74M  
Lower incisors  
& roots

06



786-142  
Fig. 74N  
Lower incisors  
& roots



786-143  
Fig. 75  
Lower premolars  
& canines



786-144  
Fig. 76  
Upper roots

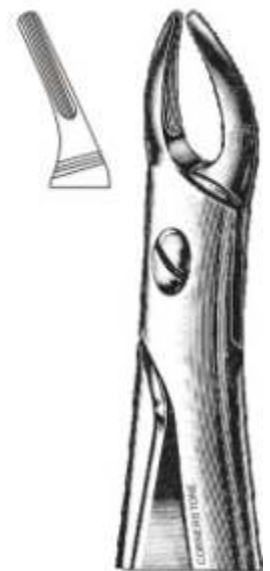

786-145  
Fig. 76N  
Upper roots  
(narrow beak)



# Extracting Forceps English Pattern



786-146  
Fig. 79  
Lower wisdoms

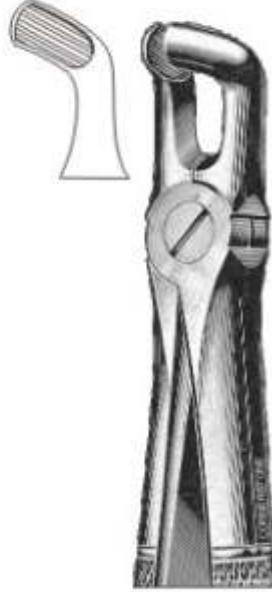

786-147  
Fig. 79A  
Lower wisdoms



786-148  
Fig. 86A  
Lower molars



786-149  
Fig. 86B  
Lower molars



786-150  
Fig. 86C  
Lower molars

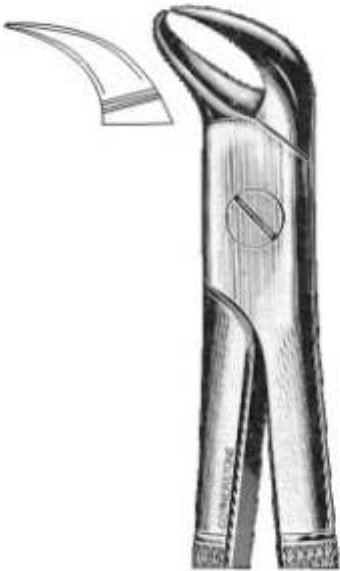

786-151  
Fig. 87  
Cowhorn beak



786-152  
Fig. 89  
Right upper molars

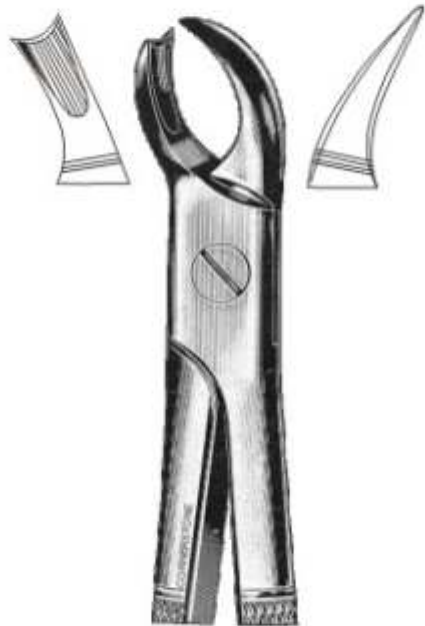

786-153  
Fig. 90  
Left upper molars

# Extracting Forceps English Pattern



786-154  
Fig. 94  
Right upper molars

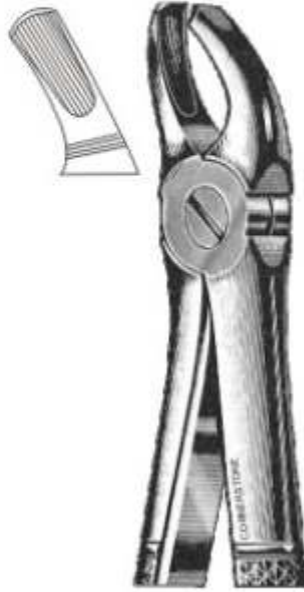

786-155  
Fig. 95  
Left upper molars

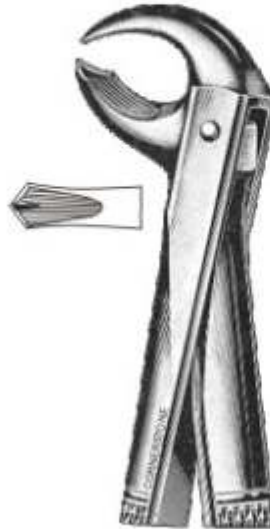

786-156  
Fig. 99  
Lower molars  
(broken-down)



786-157  
Fig. 99 1/4  
Lower molars  
(broken-down)



786-158  
Fig. 121  
Upper wisdoms



786-159  
Fig. 136  
Upper centrals  
& roots

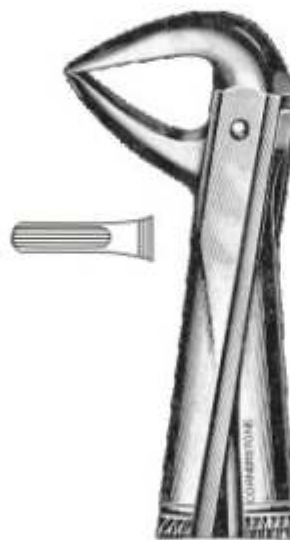

786-160  
Fig. 137  
Lower centrals  
& roots

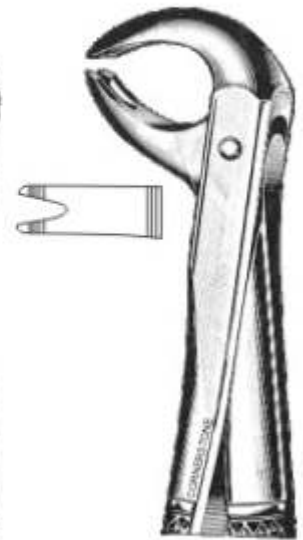

786-161  
Fig. 167  
Universal patter  
for lower teeth  
molars & premolars

# Extracting Forceps English Pattern



786-162  
Fig. 168  
Upper canines



786-163  
Fig. 169  
Lower canines  
& premolars



786-164  
Fig. 233  
Lower roots  
(parallel beaks)



786-165  
Fig. 235  
Upper roots  
(parallel beaks)



786-166  
Fig. MD 1  
Universal forceps for upper  
wisdoms, premolars & roots



786-167  
Fig. MD 2  
Upper molars



786-168  
Fig. MD 3  
Lower incisors, premolars  
& roots

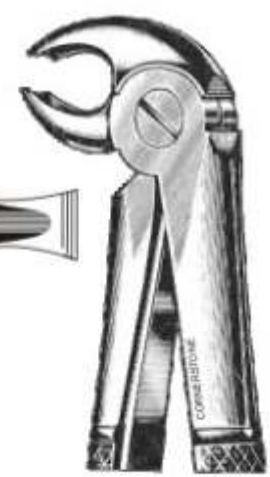

786-169  
Fig. MD 4  
Lower molars



# Extracting Forceps Children's Pattern

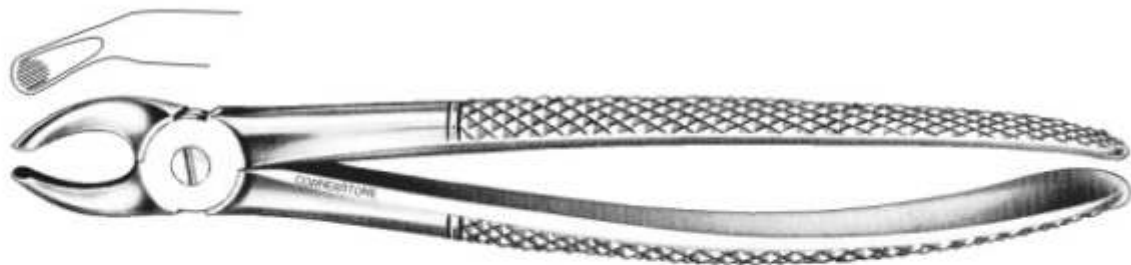

786-170  
Fig. 158  
Children's upper molars universal



786-171  
Fig. 159  
Children's upper teeth universal

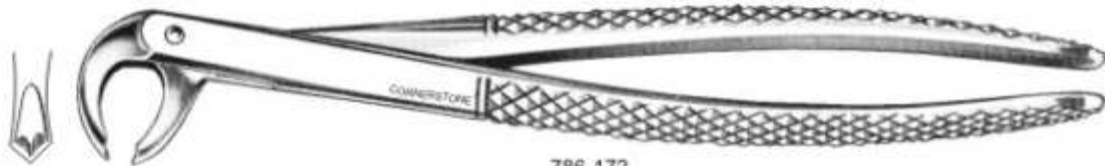

786-172  
Fig. 160  
Children's lower molars universal(hawk's bill)



786-173  
Fig. 161  
Children's lower centrals & roots

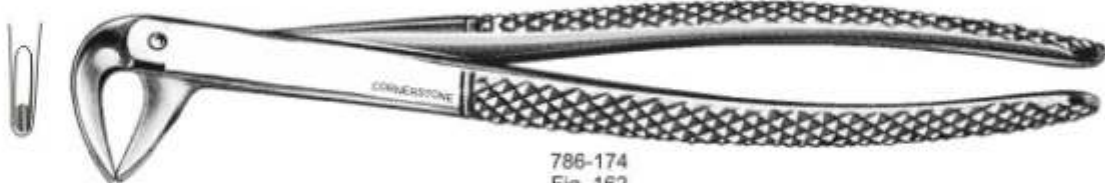

786-174  
Fig. 162  
Children's upper centrals



786-175  
Fig. 163  
Children's upper centrals

# Extracting Forceps English Pattern

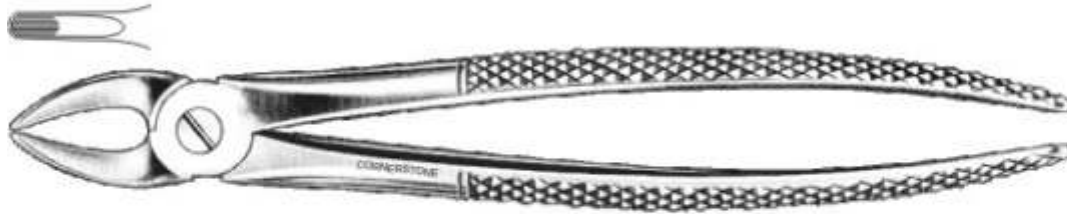

786-176  
Fig. 37  
Children's upper incisors & canines

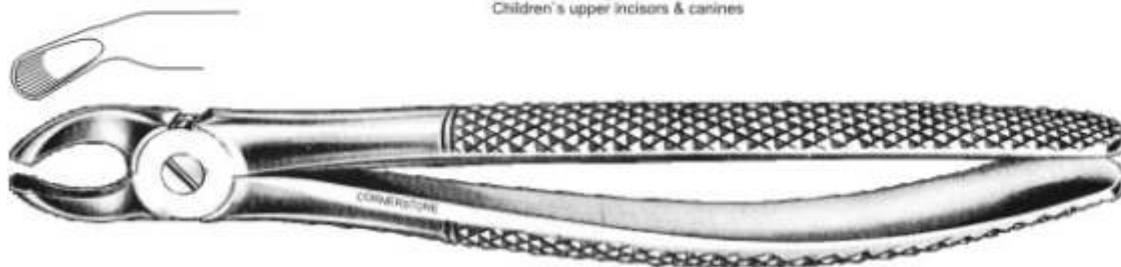

786-177  
Fig. 39  
Children's upper molars universal

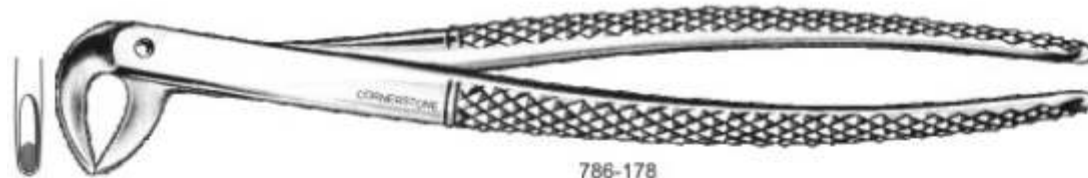

786-178  
Fig. 123  
Children's lower teeth universal



786-179  
Fig. 138  
Children's upper universal & roots



786-180  
Fig. 157  
Children's upper molars universal

Wisdom Teeth Extracting Forceps  
Root Fragment Forceps



786-181  
universal pattern for upper teeth



786-182  
universal pattern for lower teeth

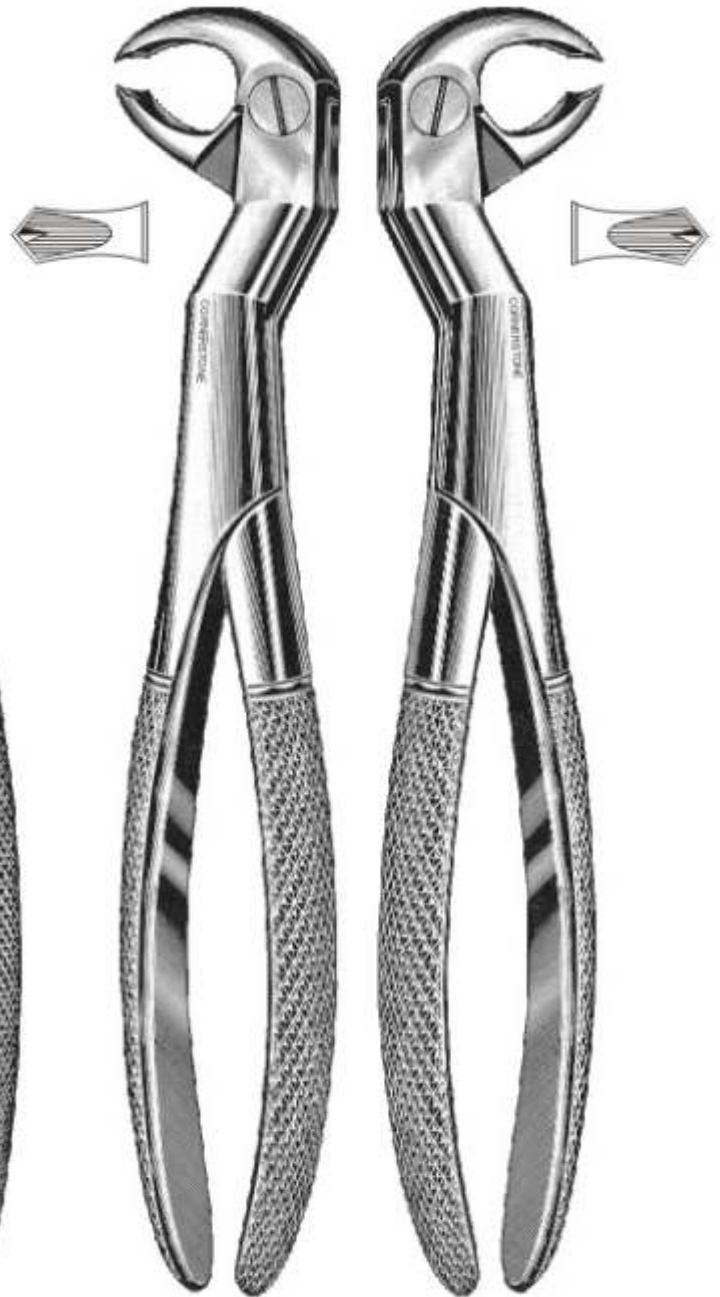

786-183  
Fig. 22 1/2 L  
Left lower wisdoms  
& molars

786-184  
Fig. 22 1/2 R  
Right lower wisdoms  
& molars



Tooth Extracting Forceps  
for children's with Spring



786-185  
Fig. 3  
Upper molars

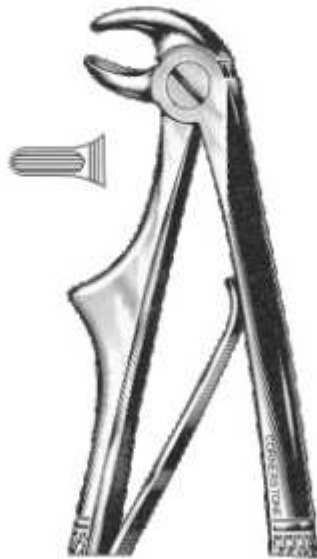

786-186  
Fig. 5  
Lower incisors



786-187  
Fig. 6  
Lower molars

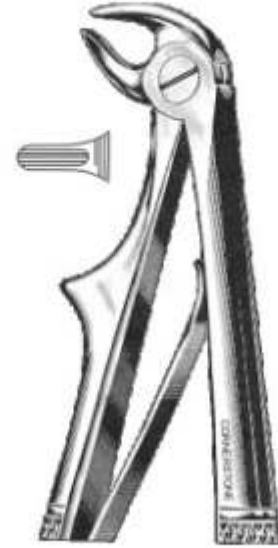

786-188  
Fig. 7  
Lower roots



786-189  
Fig. 137  
Upper incisors  
& canines



786-190  
Fig. 139  
Upper premolars



786-191  
Fig. 51S  
Upper roots

# Tooth Extracting Forceps American Pattern



786-192  
Fig. 1  
Upper centrals, laterals & cuspids

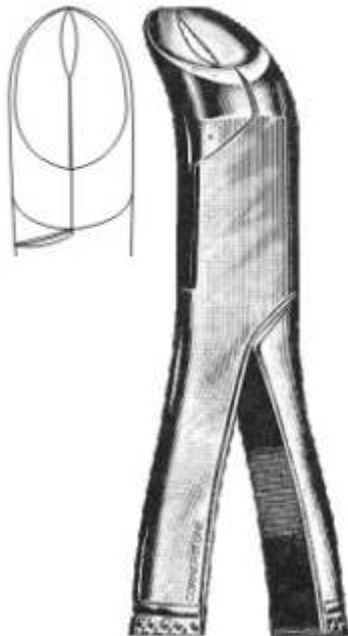

786-193  
Fig. 5  
Lower third molars

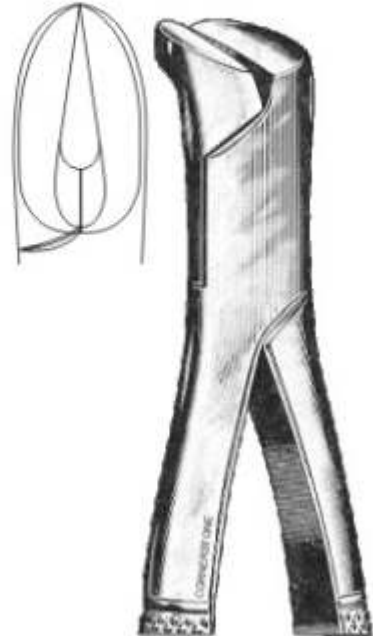

786-194  
Fig. 6  
Splitting forceps

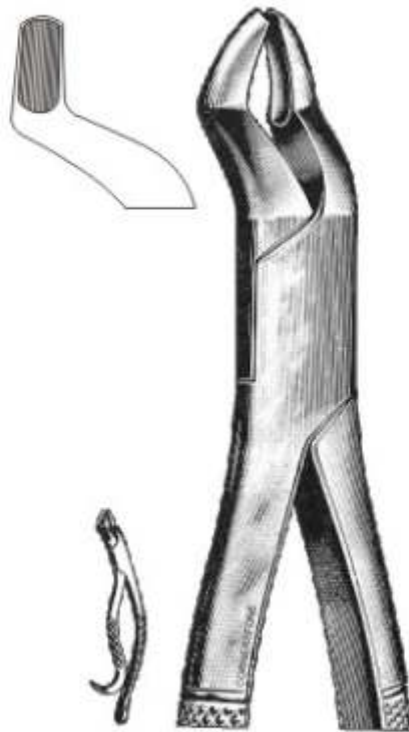

786-195  
Fig. 10 H  
upper molars  
hook - handle



786-196  
Fig. 10 S  
upper molars  
straight - handle



786-197  
Fig. 15  
Lower molars

Tooth Extracting Forceps  
American Pattern

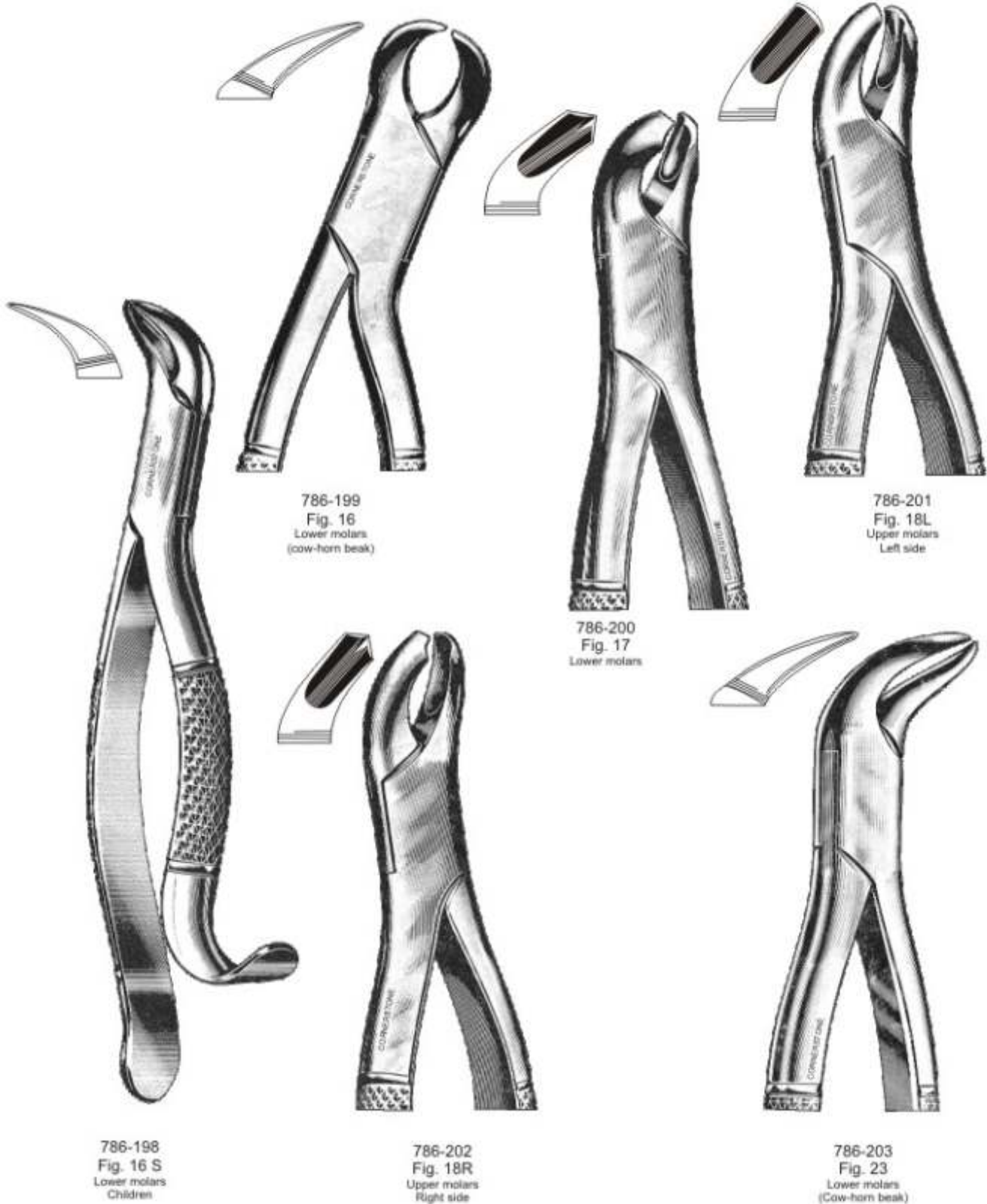



# Tooth Extracting Forceps American Pattern



786-204  
Fig. 32  
Upper molars  
& pre molars  
strong beak

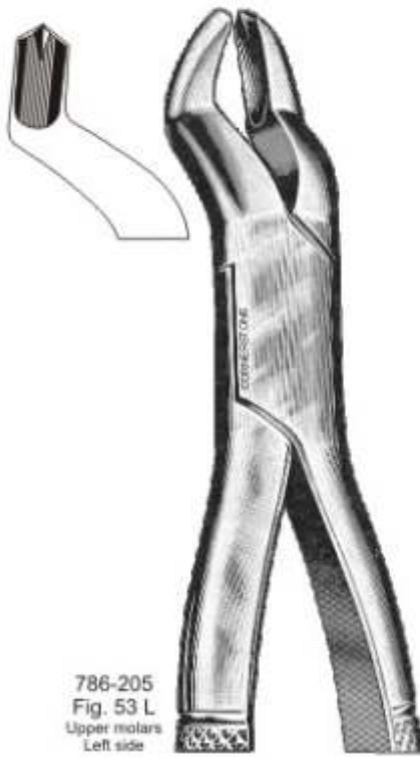

786-205  
Fig. 53 L  
Upper molars  
Left side

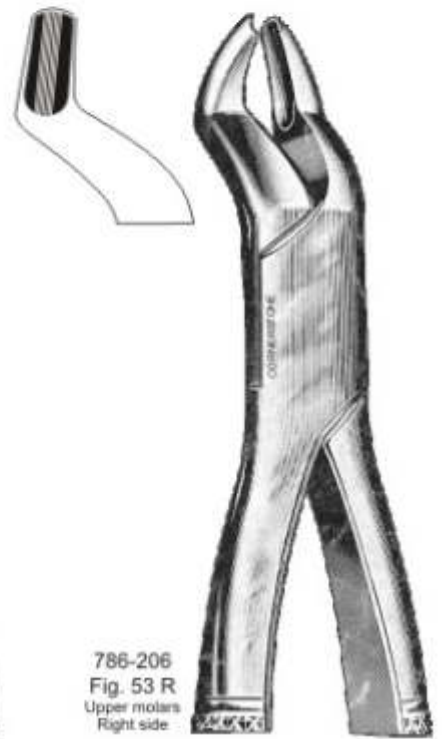

786-206  
Fig. 53 R  
Upper molars  
Right side



786-207  
Fig. 62  
Universal forceps  
for upper teeth & roots

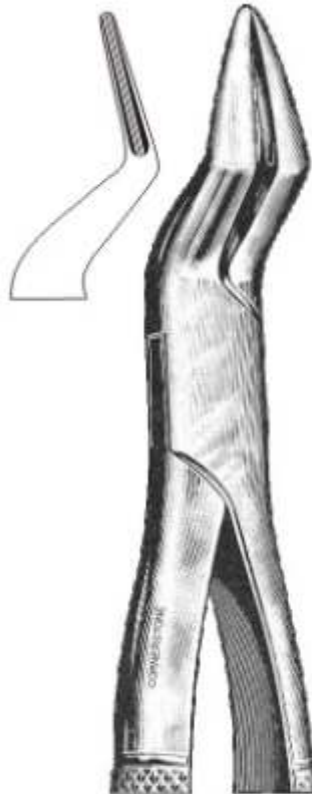

786-208  
Fig. 65  
upper incisors & root



786-209  
Fig. 69  
Fragments & small roots  
Upper & Lower

Tooth Extracting Forceps  
American Pattern

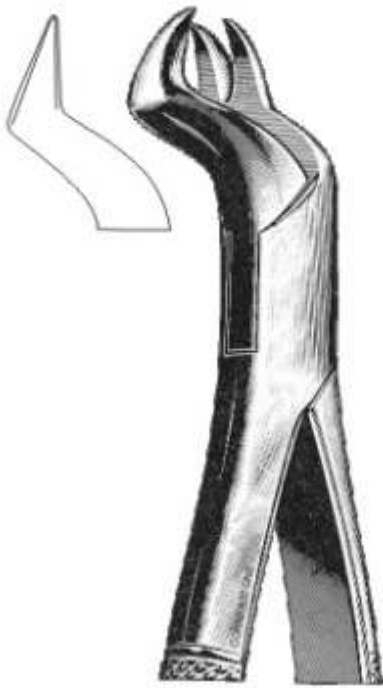

786-210  
Fig. 88R  
Right upper molars

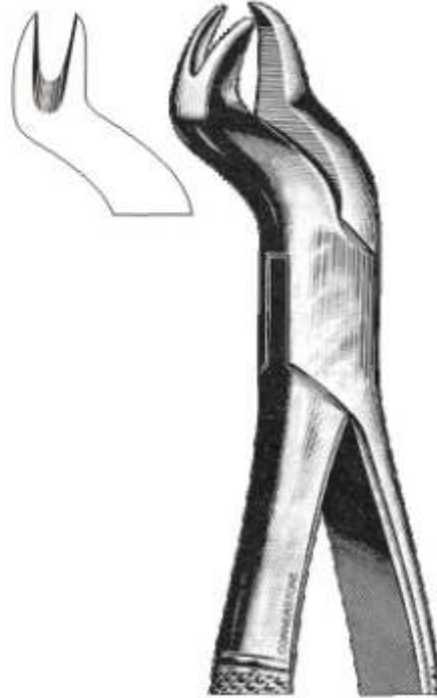

786-211  
Fig. 88L  
Left upper molars

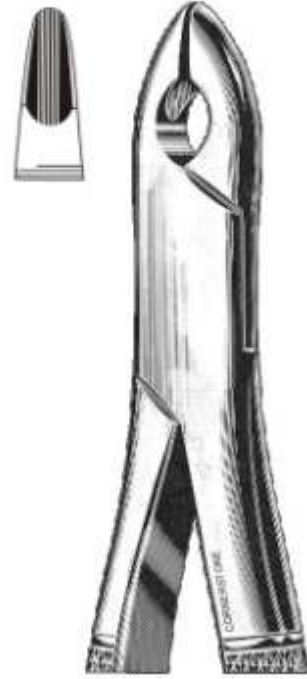

786-212  
Fig. 99C  
upper premolars,  
molar & incisors



786-213  
Fig. 101  
Universal forceps  
for premolars.



786-214  
Fig. 150  
Upper premolars,  
incisors & roots



786-215  
Fig. 150A  
Upper premolars,  
incisors & roots



786-216  
Fig. 150S  
Upper premolars,  
incisors & roots  
for children

# Tooth Extracting Forceps American Pattern

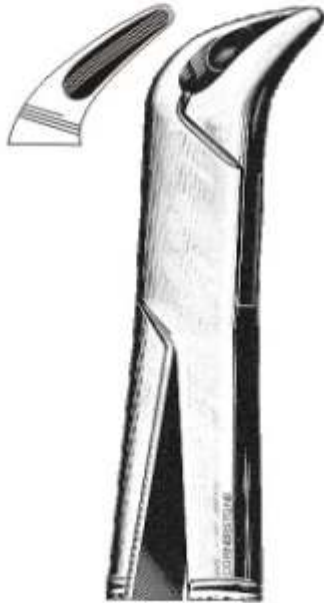

786-217  
Fig. 151  
Lower premolars, incisors & roots



786-218  
Fig. 151A  
Lower premolars, incisors & roots

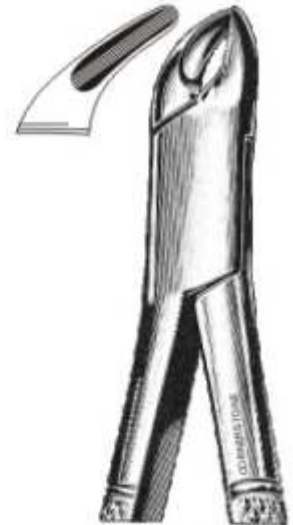

786-219  
Fig. 151S  
Lower premolars, incisors & roots  
for children

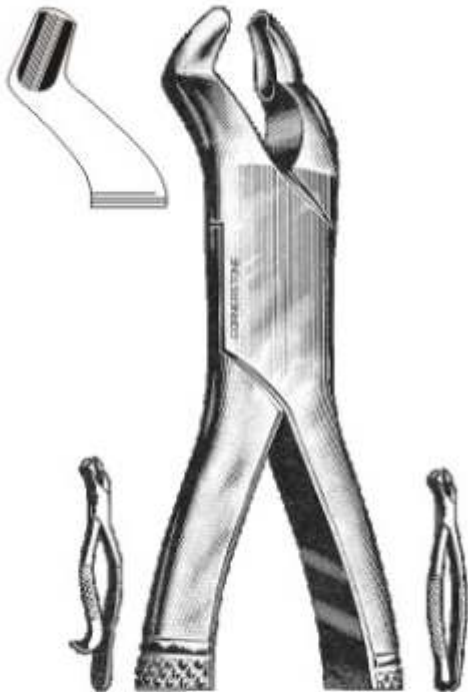

786-220  
Fig. 210H  
Upper wisdoms  
with hook handle



786-221  
Fig. 210S  
Upper wisdoms  
with straight handle



786-222  
Fig. 222  
Lower wisdoms



786-223  
Fig. 286  
Upper roots, premolars & incisors



Root Splinter Forceps  
Extraction Tweezer



786-224  
Fig. 1  
Lower roots

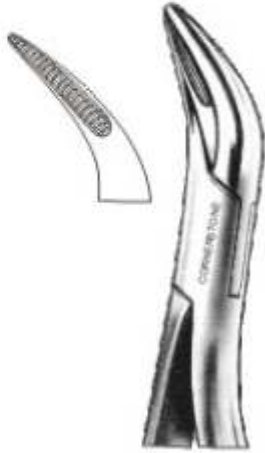

786-225  
Fig. 2  
Upper roots



786-226  
Albrecht  
16 cm



786-227  
Albrecht  
16 cm

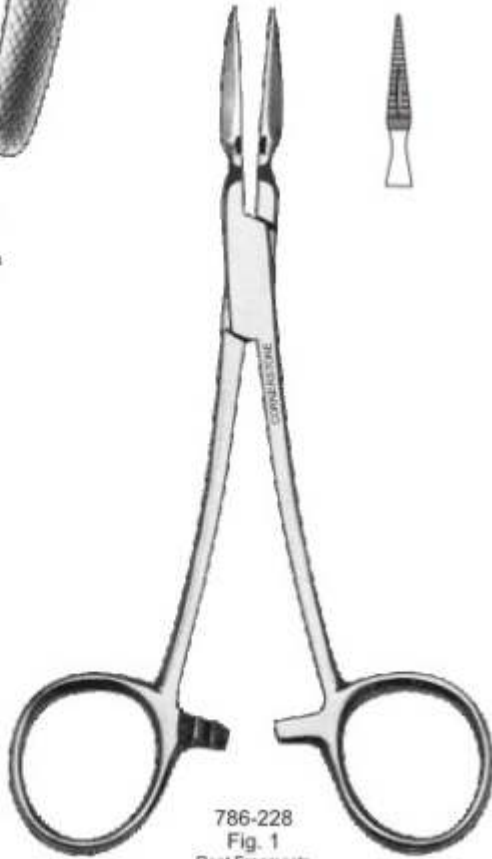

786-228  
Fig. 1  
Root Fragments



786-229  
Fig. 2  
Root Fragments

# Bone Rongeurs



**777-230**  
Blumenthal  
15 cm



**777-231**  
Blumenthal 45°  
14,5 cm



**777-232**  
Blumenthal 90°  
14 cm



**777-233**  
Mead 1A  
16,5 cm

20



**777-234**  
Beyer  
18 cm  
Multiple Action



**777-235**  
Ruskin-mini  
15,5 cm



**777-236**  
Luer  
15 cm



**777-237**  
Friedman  
14 cm



**777-238**  
Mini-Friedman  
12 cm

# Root Elevators



777-240  
Fig.2B  
Bein



777-241  
Fig.3B  
Bein



777-242  
Fig.4B  
Bein



777-243  
Fig.5B  
Bein



777-244  
Fig.6B  
Bein



777-245  
Fig.4SA

777-246  
Fig.5SA

Schmeckebier-Apexo

777-239  
Fig.1B  
Bein



777-247  
Fig.34S  
Seldin



777-248  
Fig.34  
Seldin



777-249  
Fig.2S  
Seldin



777-250  
Fig.3S  
Seldin



777-251  
Fig.1F  
Flohr



777-252  
Fig.2F  
Flohr



777-253  
Fig.3F  
Flohr



# Root Elevators



# Root Elevators



786-269  
Fig.A  
Cogswell



786-270  
Fig.B  
Cogswell



786-271  
Fig.301  
Apexo



786-272  
Fig.302  
Apexo



786-273  
Fig.303  
Apexo



786-274  
Fig.301W  
Seldin



786-275  
Fig.304W  
Seldin



786-276  
Fig.1H  
Heidbrink



786-277  
Fig.2H  
Heidbrink



786-278  
Fig.40H  
Heidbrink



786-279  
Fig.41H  
Heidbrink



786-280  
Fig.46



786-281  
Fig.46R

# Root Elevators

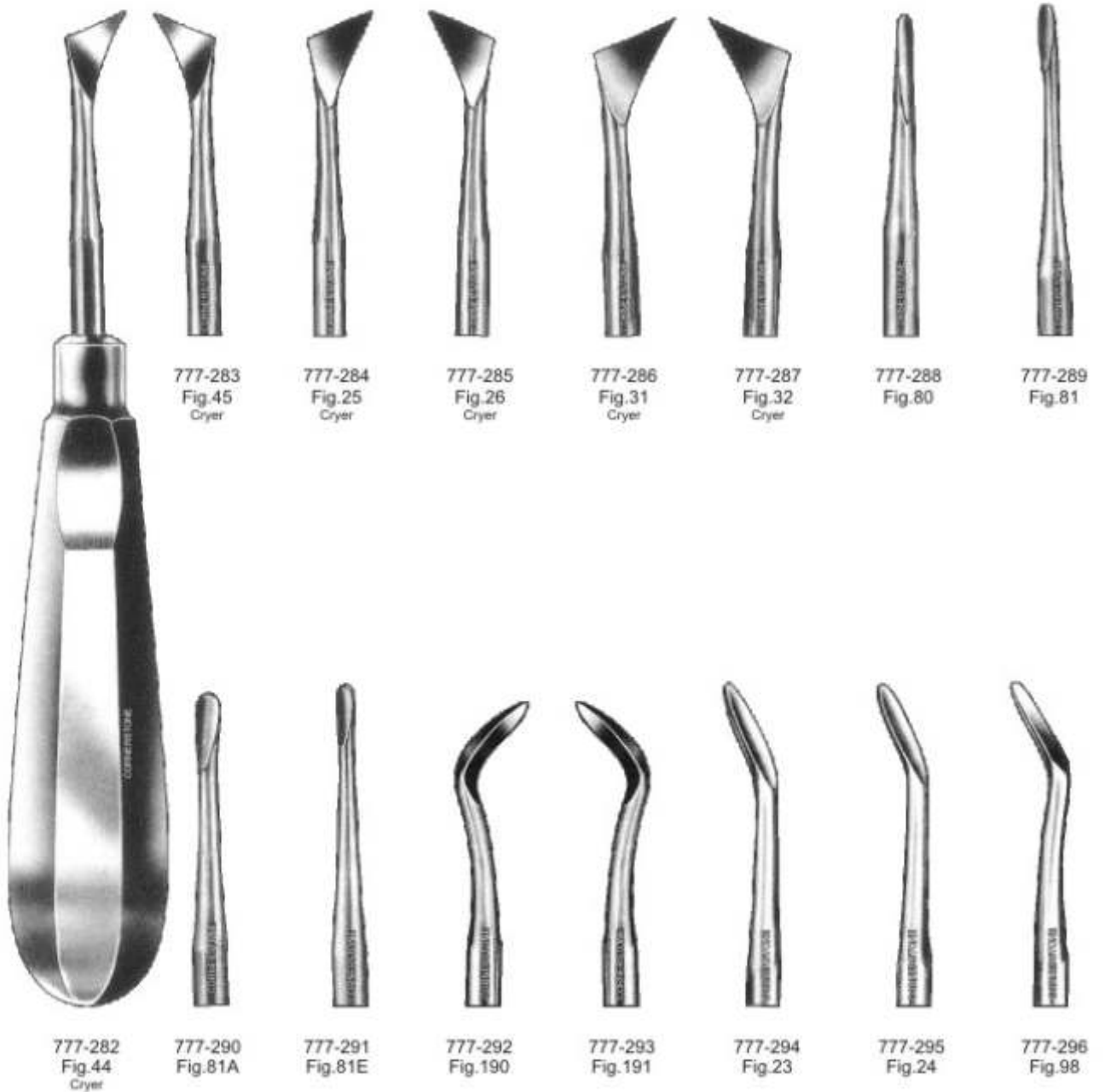



# Root Elevators



# Root Elevators



786-313  
Fig.1  
Bein



786-314  
Fig.2  
Bein



786-315  
Fig.3  
Bein



786-316  
Fig.4  
Bein



786-317  
Fig.5  
Bein



786-318  
Fig.6  
Bein



786-319  
Fig.1



786-320  
Fig.2



786-321  
Fig.2  
Fluhr



786-322  
Fig.3  
Fluhr



786-323  
Fig.7  
Cryer



786-324  
Fig.8  
Cryer

# Root Elevators

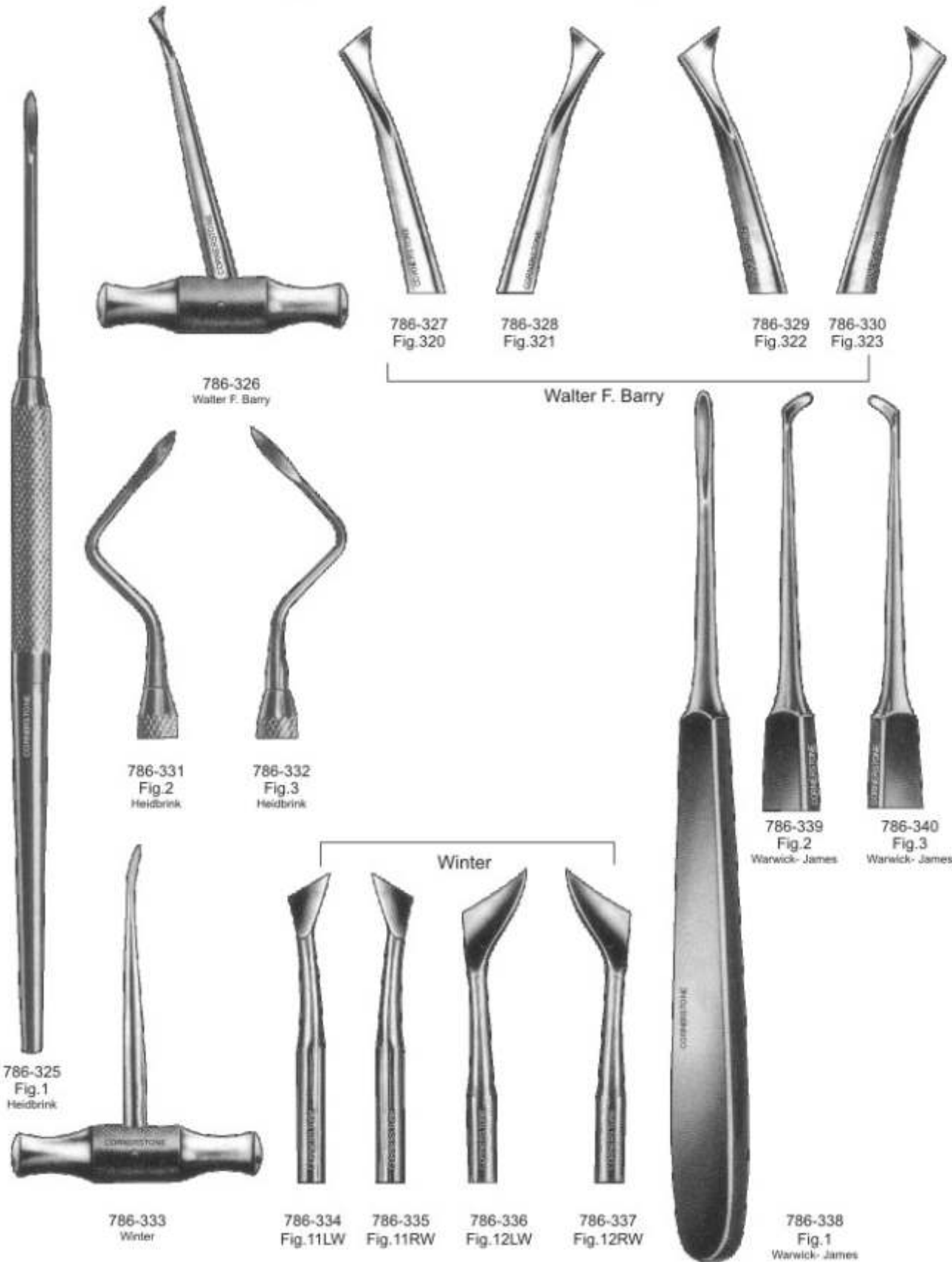



# Pliers For Orthodontics & Prosthetics



786-341  
Waldsachs  
15 cm



786-342  
Universal  
16 cm



786-343  
Nance  
13.5 cm



786-344  
Adener  
14,5 cm



786-345  
Modell marburg  
Serrated Jaws  
14 cm

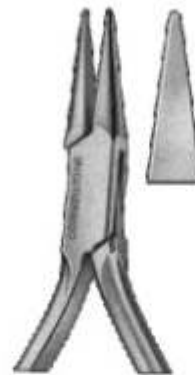

786-346  
Modell marburg  
Smooth jaws  
14 cm

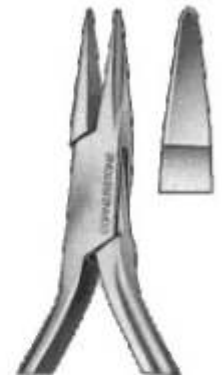

786-347  
Modell marburg  
Carbid Inserts jaws  
14 cm



786-348  
Goslee  
One Serrated Jaws  
14 cm

# Pliers For Orthodontics & Prosthetics



**786-349**  
14 cm



**786-350**  
14 cm



**786-351**  
14 cm



**786-352**  
14.5 cm



**786-353**  
14.5 cm



**786-354**  
14 cm



**786-355**  
14 cm



**786-356**  
14 cm



**786-357**  
Serrated Jaws  
12 cm



**786-358**  
How  
14.5 cm



**786-359**  
How-angled  
14.5 cm



**786-360**  
Arrow clasp forming  
12 cm



**786-361**  
Arrow clasp forming  
12 cm



**786-362**  
Arrow clasp bending  
12 cm

# Pliers For Orthodontics & Prosthetics



786-363  
Peeso  
13,5 cm

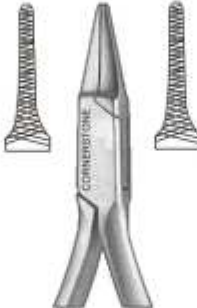

786-364  
Peeso  
13,5 cm



Round nose pliers

786-365  
14 cm



786-366  
Langenbeck  
14 cm

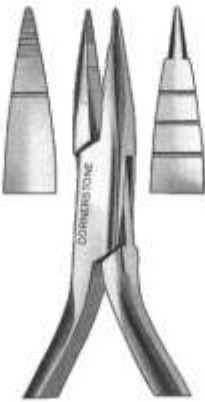

786-367  
14 cm



786-368  
13 cm



786-369  
Angle  
12,5 cm

For wire up to



786-370  
Andresen  
13 cm

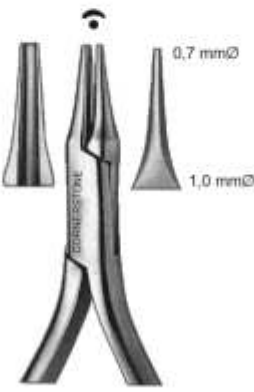

786-371  
13,5 cm



786-372  
Schwarz  
13,5 cm



786-373  
Fischer  
13 cm

**Pliers For Orthodontics  
& Prosthetics**



**786-374**  
Aderer  
12 cm



**786-375**  
Aderer- Heavy  
12 cm



**786-376**  
Tweed  
14,5 cm



**786-377**  
O'Brien  
13,5 cm



**786-378**  
Wire bending pliers  
12,5 cm



**786-379**  
Adams  
12,5 cm



**786-381**  
Young  
14 cm



**786-380**  
Frevert  
12,5 cm



**786-382**  
Clasp forming  
14 cm



# Orthodontics Instruments

Ligature instruments



786-383  
Band sealing &  
removing instruments



786-384



786-385



786-386  
Elastic instruments



786-387  
Mershon Band Pusher  
14 cm



786-388  
Band Setter with  
lin insert  
15 cm



786-389  
13.5 cm



786-390  
14 cm

Bracket holding tweezer

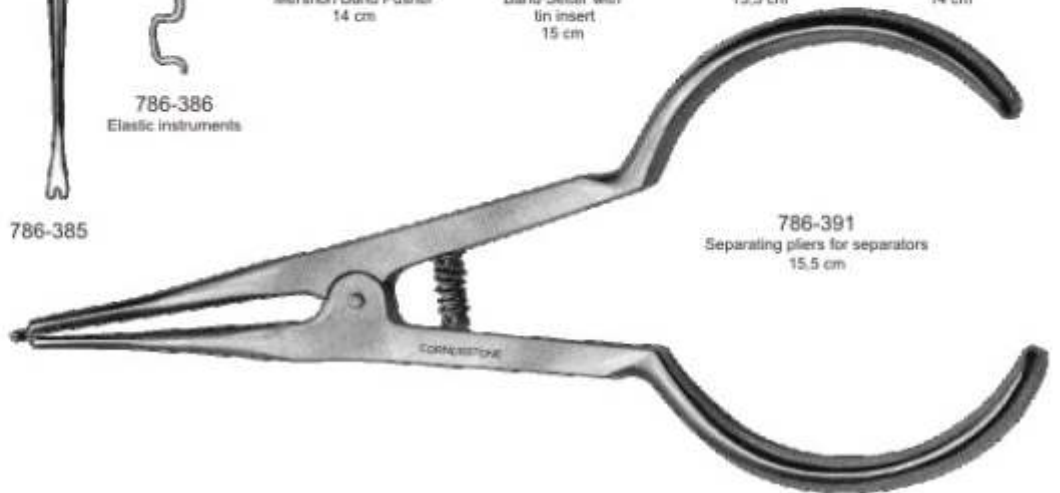

786-391  
Separating pliers for separators  
15.5 cm

# Orthodontics Instruments

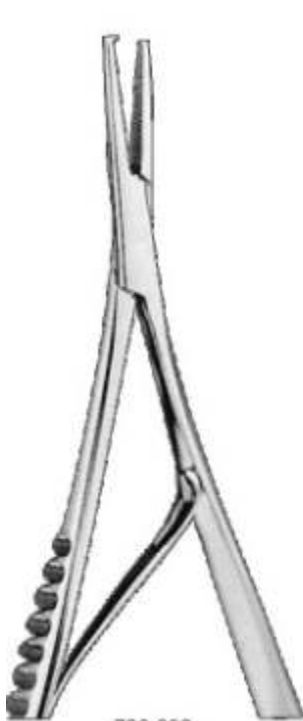

786-392  
Mathieu pliers  
14 cm



786-393  
Elastic ligature placing pliers  
14 cm



786-394  
Mathieu ligating pliers  
14 cm



786-395  
Mathieu plier  
with finger ring  
14 cm



786-396  
Mosquito plier



Hook



786-398  
Bracket placing tweezer



786-399  
Bracket placing tweezer



786-397  
Bracket positioning gauge



786-400  
Ligature tying plier



786-401  
Bracket holding tweezer



786-402  
Band seating instrument  
Nylon



786-403  
Mosquito forceps

# Gum Scissors

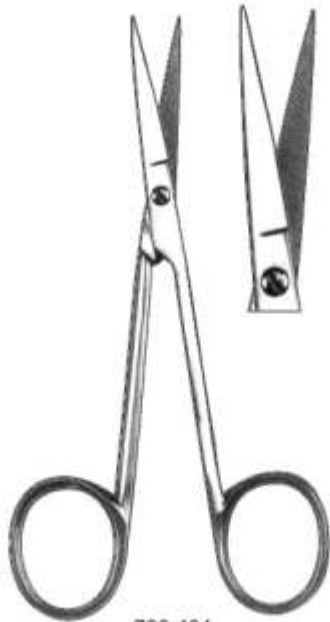

786-404  
Fig.1  
12cm  
Straight



786-405  
Fig.2  
12cm  
Curved

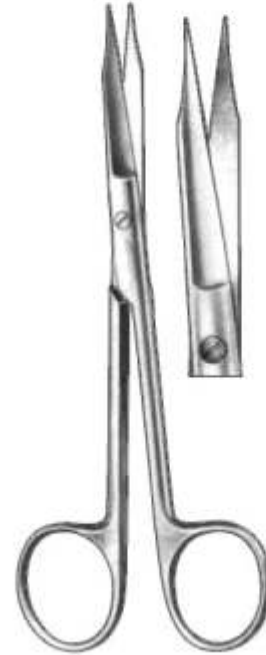

786-406  
Fig.1  
13cm  
Goldman-Fox  
Saw edge  
Straight

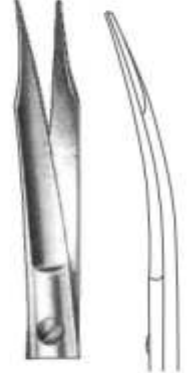

786-407  
Fig.2  
13cm  
Goldman-Fox  
Saw edge  
Curved

34



786-408  
Fig.1  
11,5cm  
Iris



786-409  
Fig.2  
11,5cm  
Iris  
Curved



786-410  
Fig.3  
11,5cm  
Iris



786-411  
Fig.1  
11,5cm  
Angular, Saw edge



786-412  
Fig.2  
11,5cm  
Angular

# Gum Scissors

Curved, saw edge



786-413  
Fig.1  
La Grange  
10.5 cm

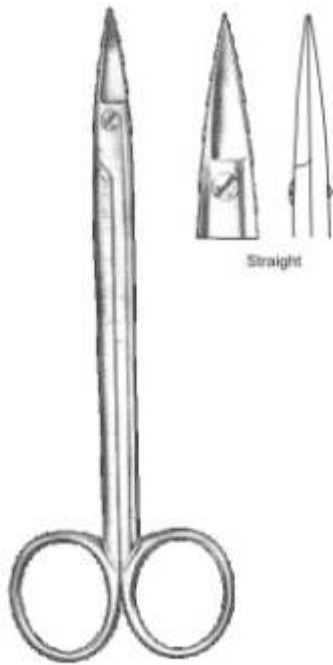

786-414  
Fig.1  
Quinby  
12.5 cm

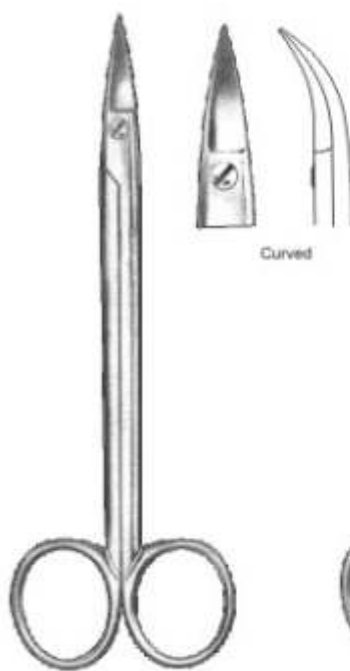

786-415  
Fig.2  
Quinby  
12.5 cm



786-416  
Fig.3  
Goldman-Fox (Special)  
13 cm

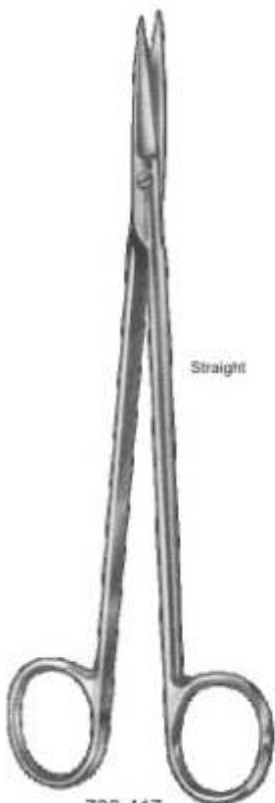

786-417  
Fig.1  
Kelly  
16 cm

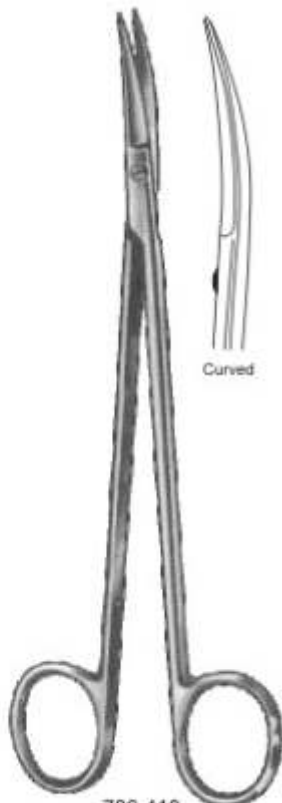

786-418  
Fig.2  
Kelly  
16 cm

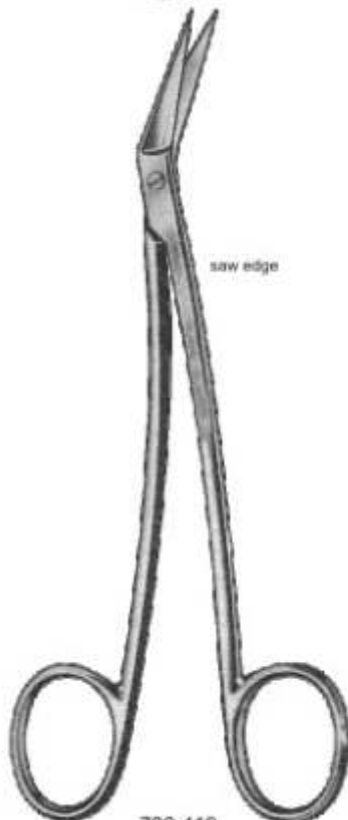

786-419  
Fig.1  
Locklin  
16.5 cm

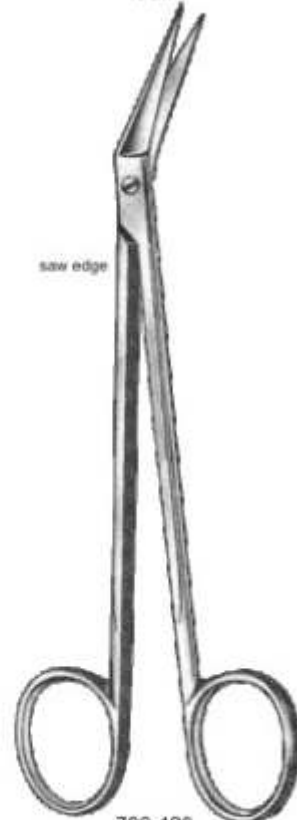

786-420  
Fig.2  
Locklin  
16.5 cm



# Surgical Scissors

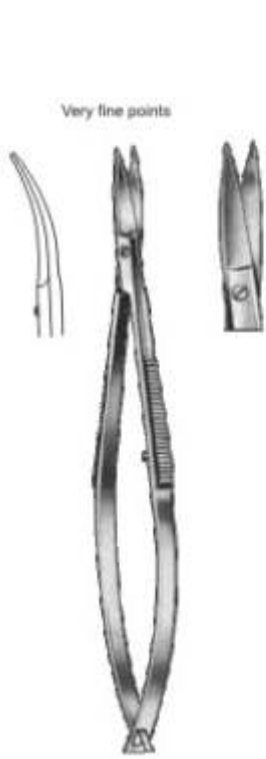

786-421  
Fig.1  
Noyes (Castroviejo)  
12 cm



786-422  
Fig.1  
14.5 cm

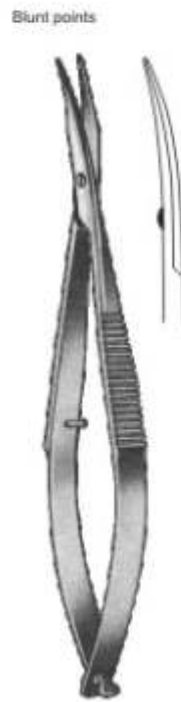

786-423  
Fig.1  
Westcott  
11 cm



786-424  
Fig.2  
Westcott  
11 cm

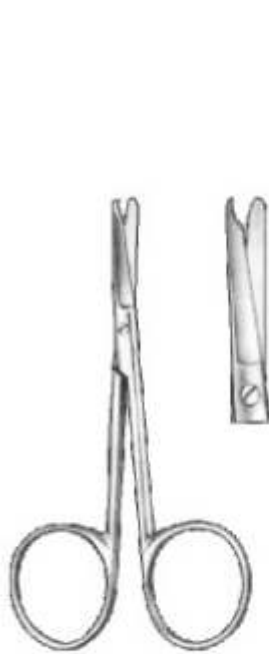

786-425  
Fig.1  
Spencer  
9 cm



786-426  
Fig.2  
Spencer  
13 cm

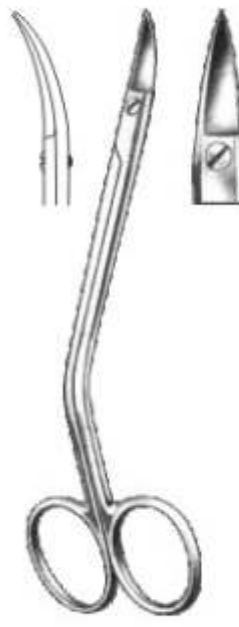

786-427  
Fig.1  
Neumann  
12.5 cm



786-428  
Fig.1  
Dean  
17 cm

Gum Scissors

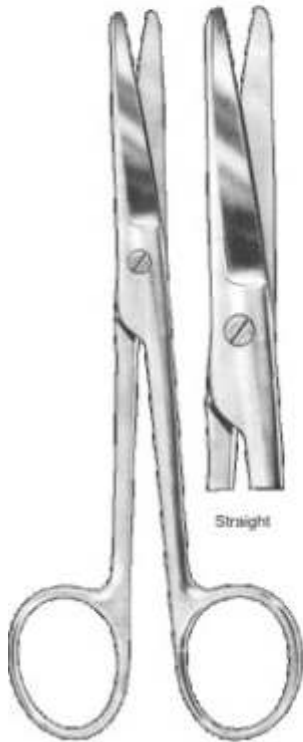

786-429  
Fig.1  
Mayo  
14,5 cm

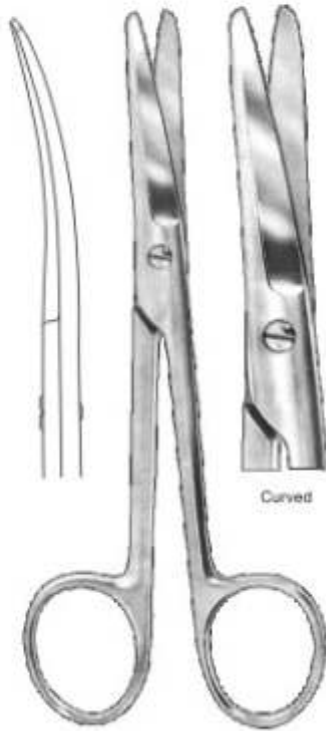

786-430  
Fig.2  
Mayo  
14,5 cm



786-431  
Fig.1  
Metzenbaum  
14,5 cm

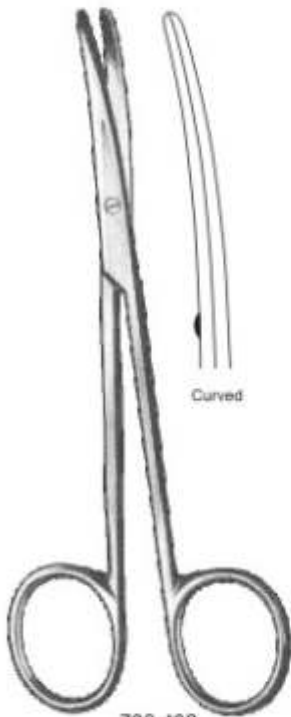

786-432  
Fig.2  
Metzenbaum  
14,5 cm

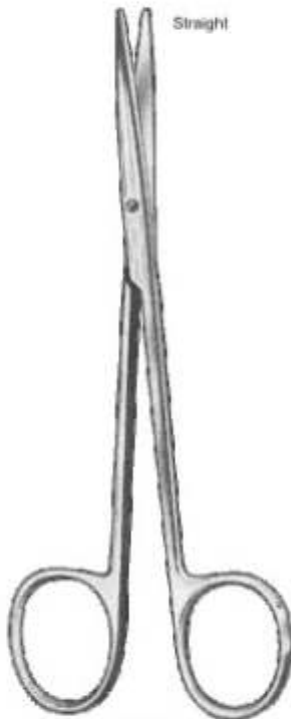

786-433  
Fig.1  
Metzenbaum-Delicate  
14,5 cm

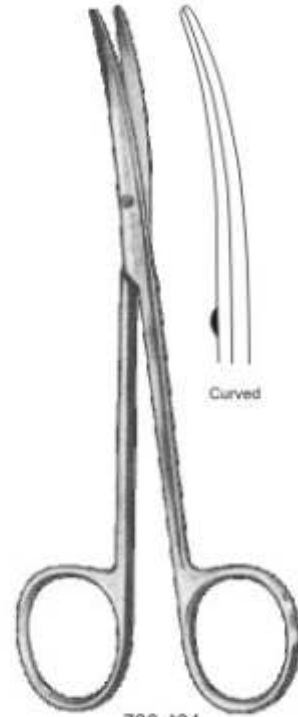

786-434  
Fig.2  
Metzenbaum-Delicate  
14,5 cm

# Haemostatic Forceps

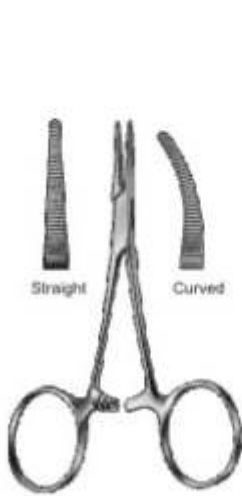

**786-435**  
Baby-Mosquito  
10 cm

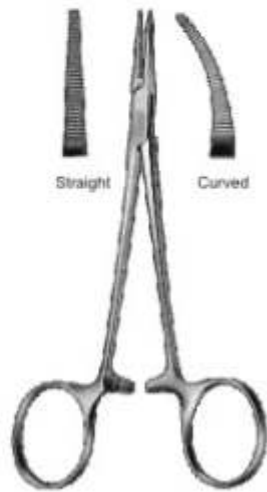

**786-436**  
Micro-Halsted  
12.5 cm

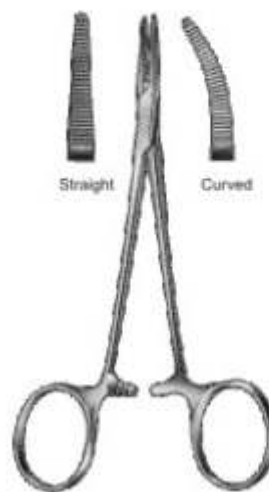

**786-437**  
Halsted-Mosquito  
12.5 cm

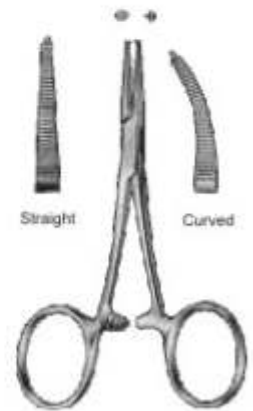

**786-438**  
Baby-Mosquito  
10 cm

38

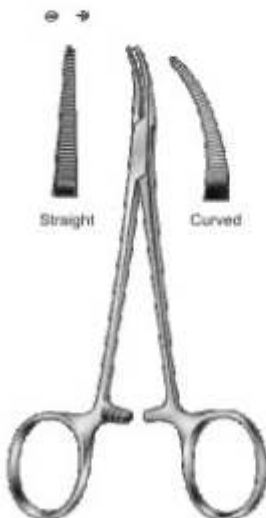

**786-439**  
Micro-Halsted  
12.5 cm

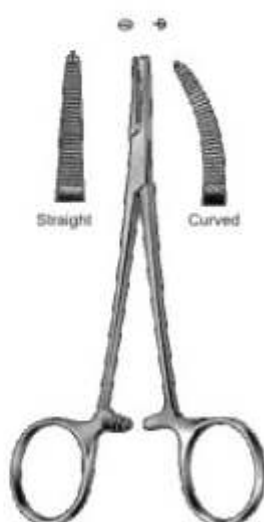

**786-440**  
Halsted-Mosquito  
12.5 cm



**786-441**  
Pean  
12.5 cm, 5"

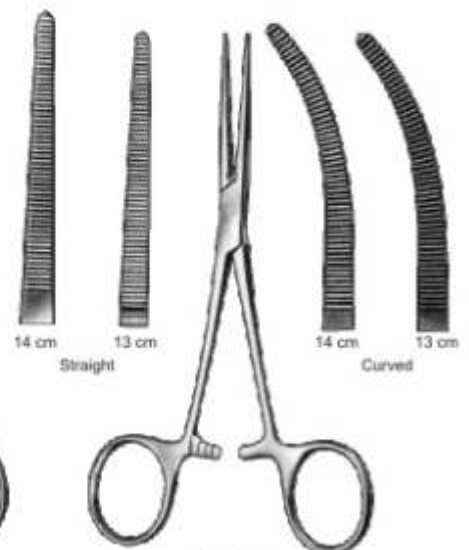

**786-442**  
Pean  
13 cm

# Haemostatic Forceps

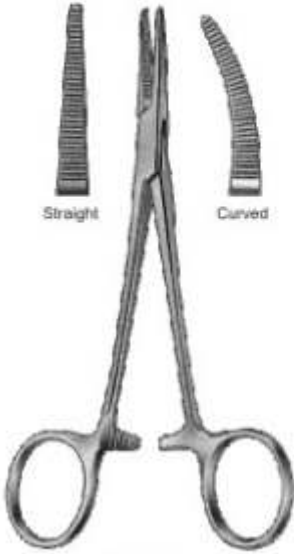

**786-443**  
Baby-Crile (Pean)  
14 cm

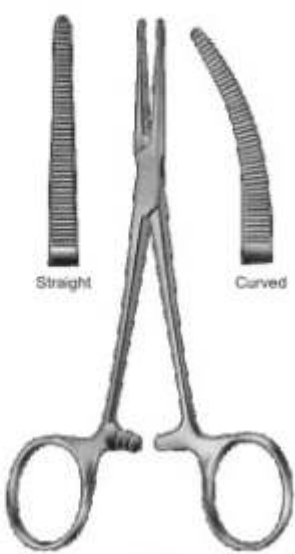

**786-444**  
Crile  
14 cm

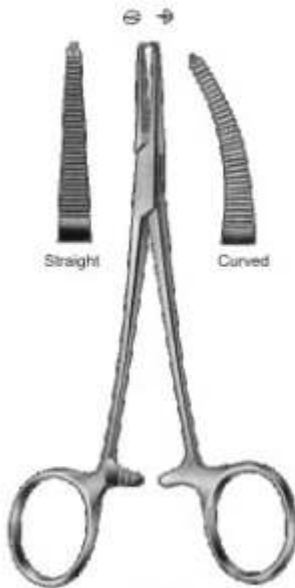

**786-445**  
Baby-Crile(Kocher)  
14 cm

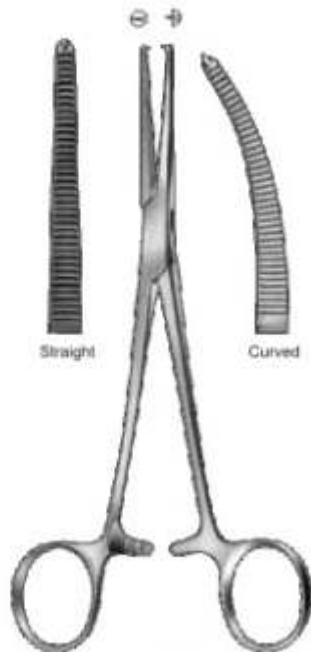

**786-446**  
Crile(Kocher)  
16 cm

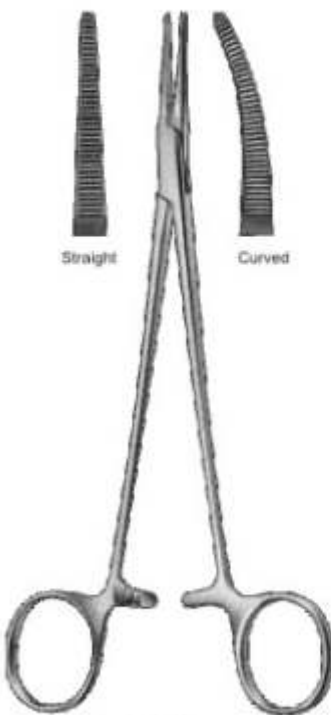

**786-447**  
Halsted  
18.5 cm

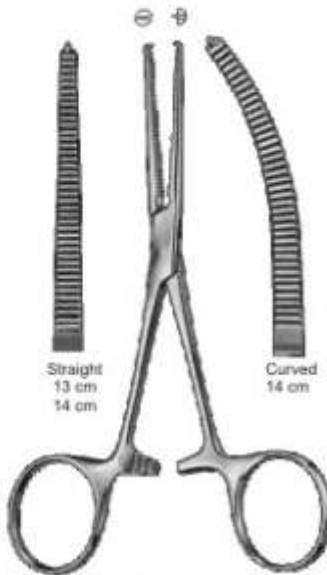

**786-448**  
Kocher

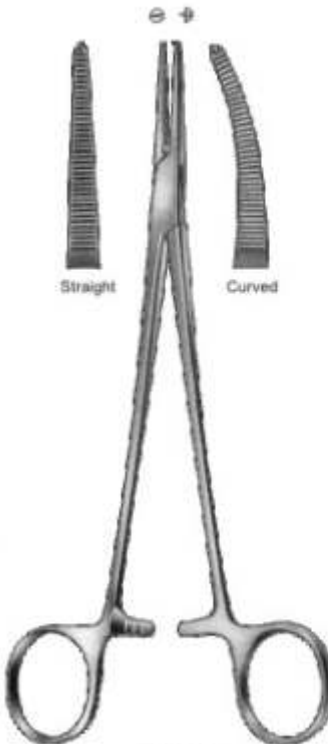

**786-449**  
Halsted  
18.5 cm

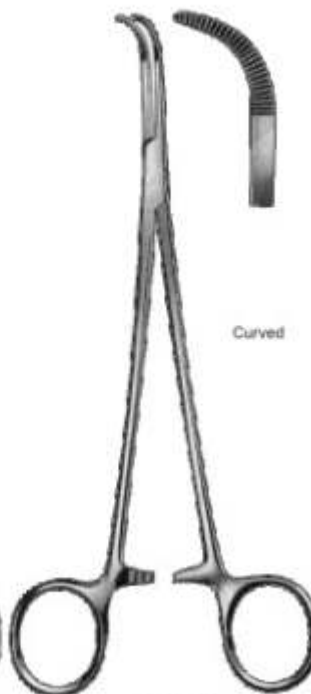

**786-450**  
Baby-Mixer  
18 cm



Sponge and Dressing forceps

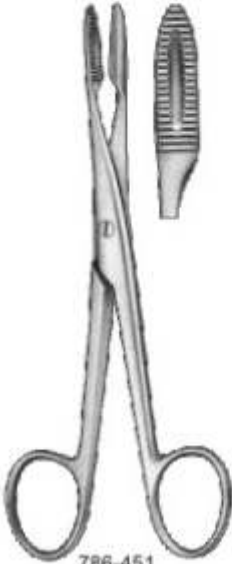

786-451  
Without Ratchet  
14.5 cm

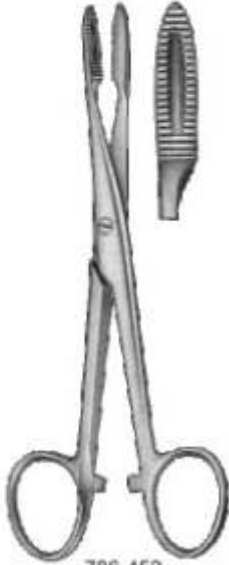

786-452  
With Ratchet  
14.5 cm



786-453  
Curved  
17.5 cm



786-454  
Curved  
21 cm

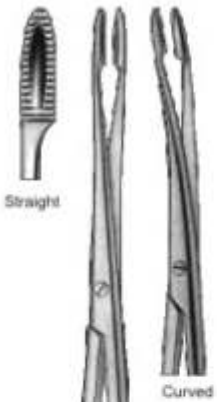

786-455  
Without Ratchet  
18 cm

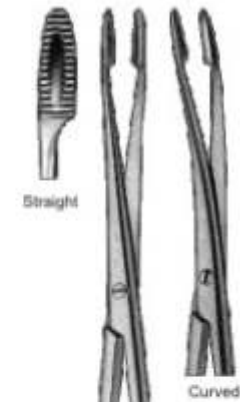

786-456  
With Ratchet  
18 cm

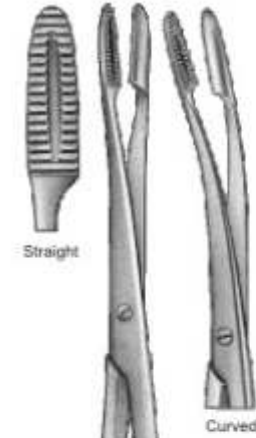

786-457  
Without Ratchet  
20 cm

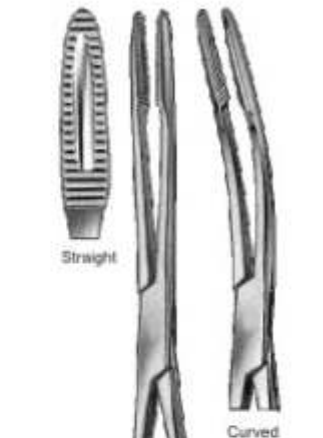

786-458  
With Ratchet  
20 cm

# Needle Holders



Designed for Frontal & Palate Suture



Needle holders with Scissors

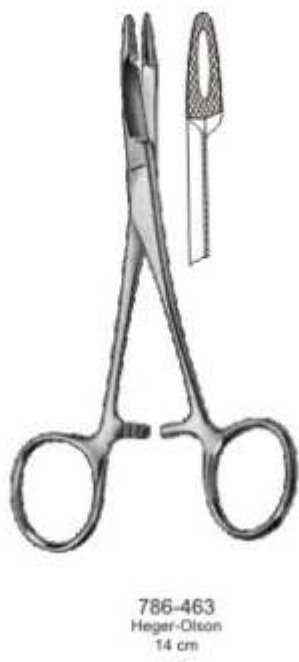

# Needle Holders



786-465  
Mathieu  
14 cm.



786-466  
Mathieu  
14 cm.

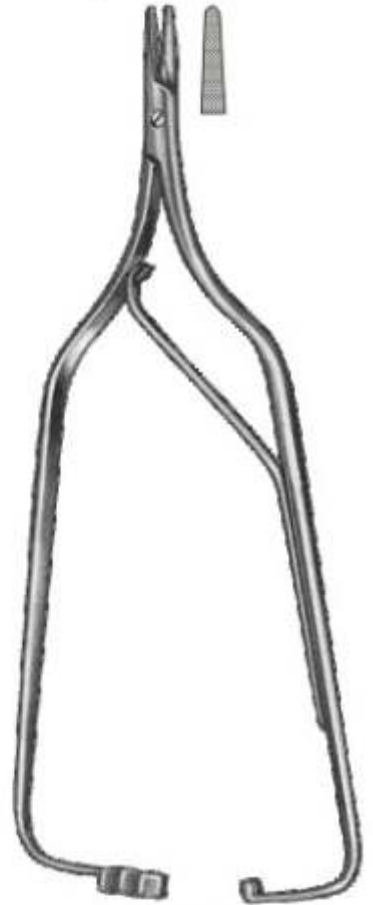

786-467  
Boynton  
12 cm.



786-468  
Castroviejo  
14 cm.



786-469  
Castroviejo  
14 cm.



786-470  
Castroviejo  
13 cm.



786-471  
Arruga  
16 cm.

Towel Clamps Sterilizing  
Forceps for Sterile Instruments

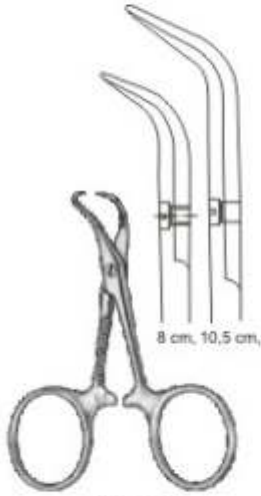

786-472  
Backhaus

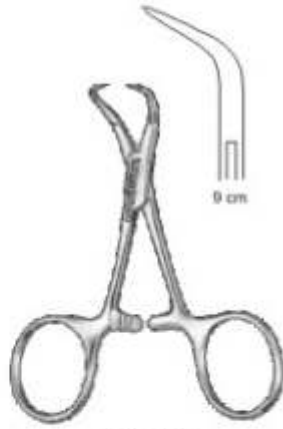

786-473  
Backhaus

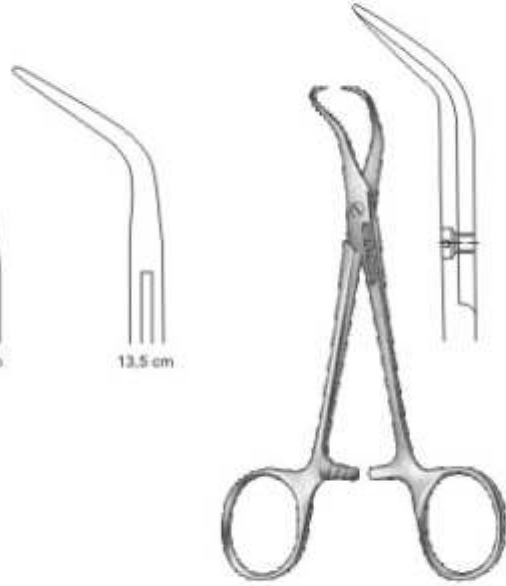

786-474  
Backhaus-Kocher  
13.5 cm

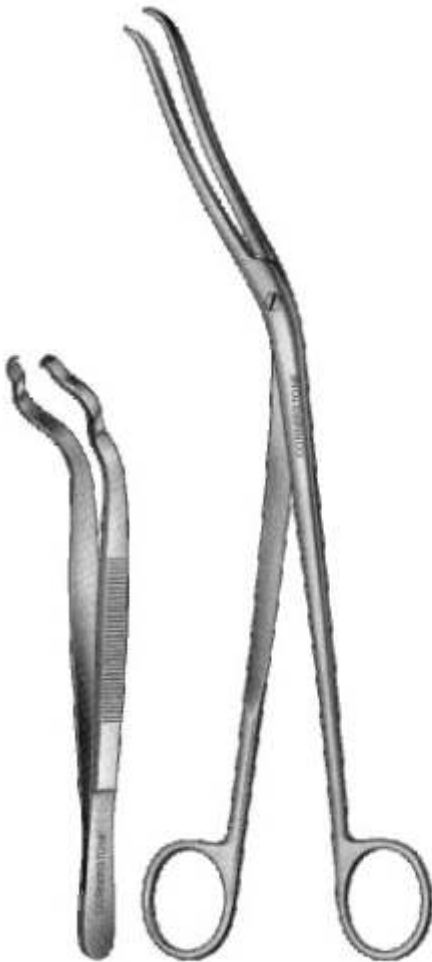

786-475  
16 cm

786-476  
Cheattle  
28 cm

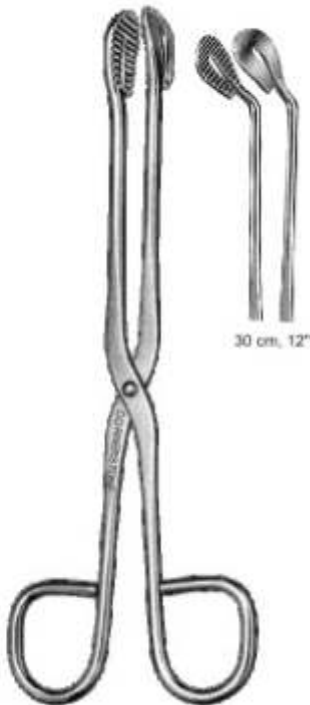

786-477  
20 cm



786-478  
20 cm, 8"



786-479  
Rogge  
23.5 cm



# Skin Hook & Retractors

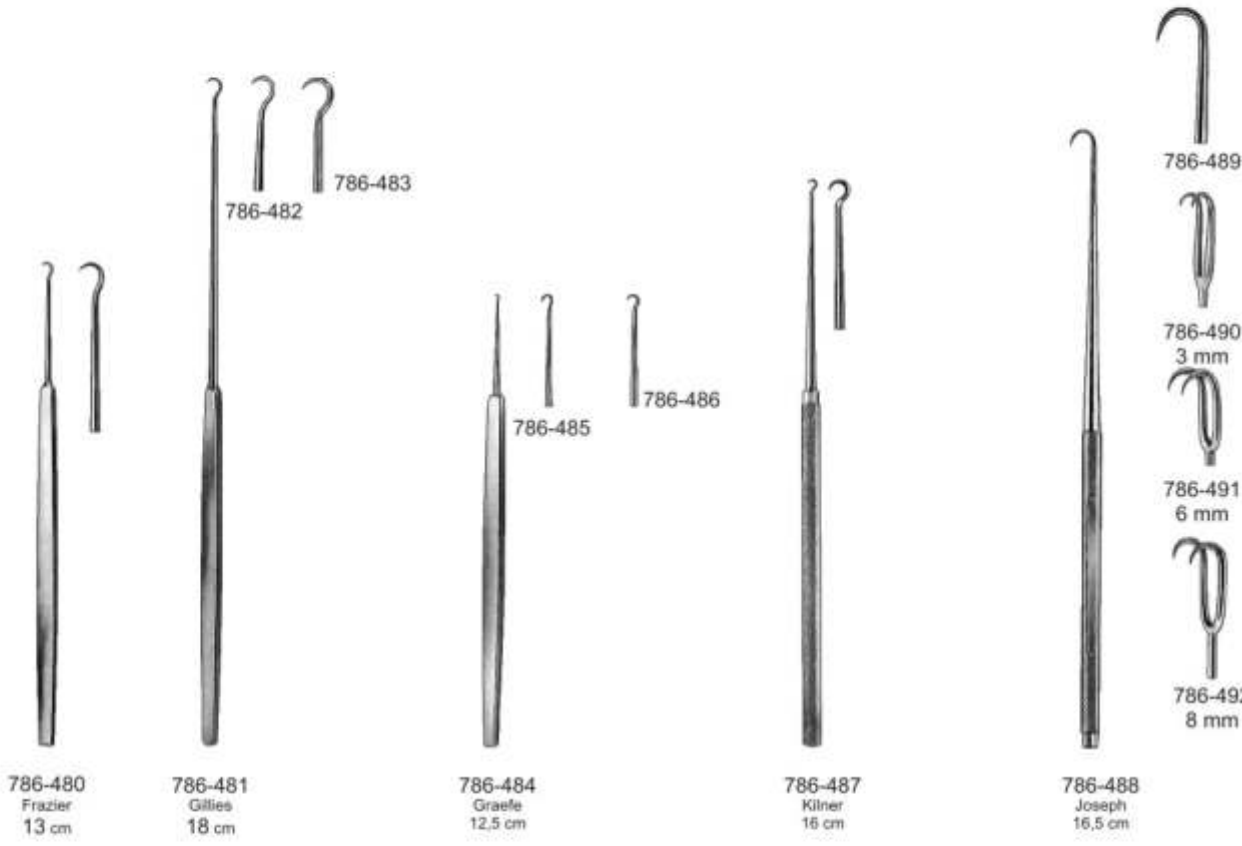

44

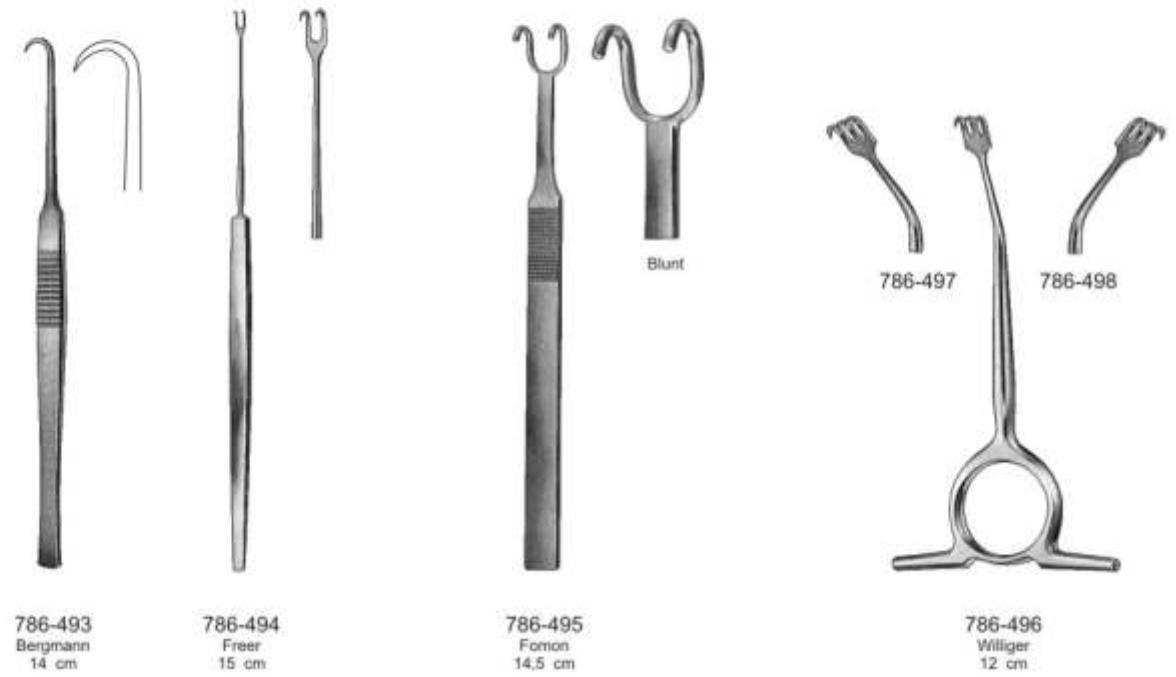

# Retractors

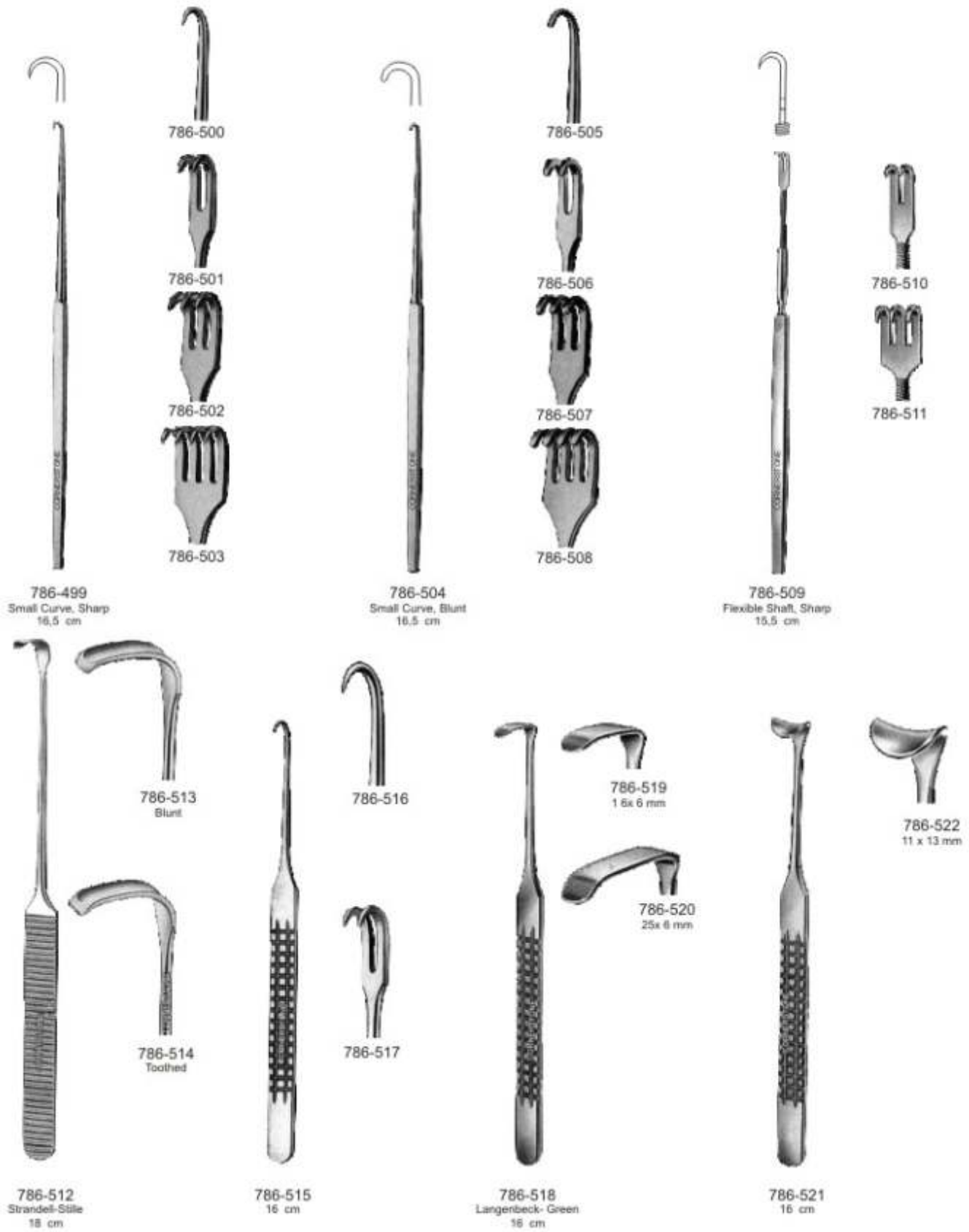

# Retractors

25 x 10 mm  
22 x 10 mm



23 x 16 mm  
20 x 16 mm



786-526 7867-527 867-528

29 mm  
26 mm  
22 mm



786-525

Roux - Set

16,5 cm

Consisting of 7867-526 19 x 22 mm

23 x 30 mm 7867-527 25 x 26 mm

28 x 38 mm 7867-528 28 x 29 mm

33 x 45 mm



28 x 12 mm  
32 x 12 mm

786-523  
Farabeuf  
12,5 cm

24 x 16 mm  
28 x 16 mm

786-524  
Farabeuf  
15 cm

28 mm  
38 mm  
45 mm



786-529  
30 x 10 mm



786-532  
25 x 6 mm



786-533  
35 x 8 mm

46



786-530  
40 x 10 mm



786-534  
35 x 11 mm



786-531  
43 x 13 mm



786-535  
35 x 15 mm

786-529  
Langenbeck  
23 cm



786-536  
41 x 11 mm



786-537  
55 x 11 mm



786-532  
Kocher-Langenbeck  
21,5 cm

# Cheek Retractors



786-538  
Middeldorpf



786-538  
15x15 mm  
22 cm



786-539  
20x22 mm  
21,5 cm



786-540  
28x28 mm  
23,5 cm



786-541  
Greene  
22,5 cm



786-542  
Bucha  
20,5 cm



786-543  
Langenbeck  
21 cm



786-543  
28x10 mm



786-544  
28x14 mm



786-545  
33x14 mm



786-546  
28x16 mm



786-547  
40x10 mm



786-548  
40x13 mm



786-549  
Kacher  
21 cm



786-550  
Alm  
7 cm

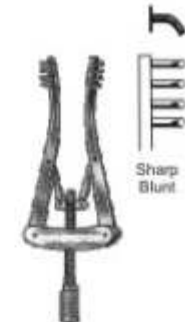

Sharp  
Blunt



786-551  
Alm  
10 cm

Sharp  
Blunt



# Elevators

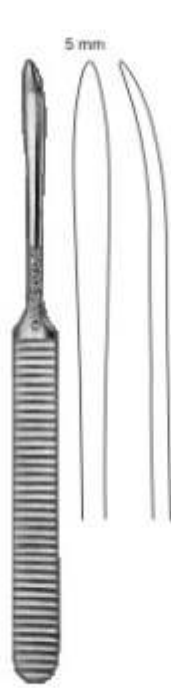

786-552  
Williger  
16,5 cm

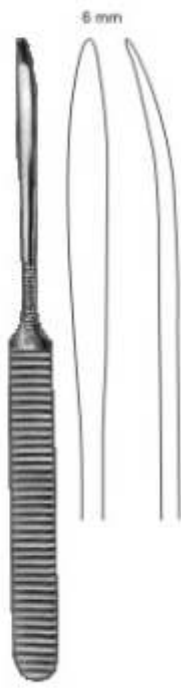

786-553  
Williger  
17 cm

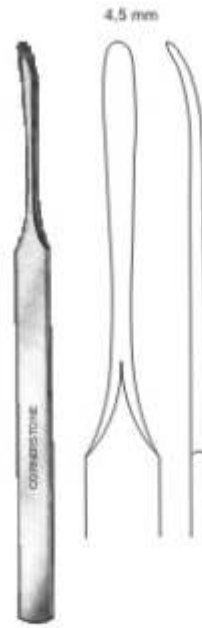

786-554  
Konig  
15,5 cm



786-555  
Konig  
15,5 cm



786-556  
Freer  
19 cm



786-557  
Freer  
18,5 cm



786-558  
Freer-Yasargin  
18,5 cm



786-559  
Kendzia  
17 cm

# Raspatories

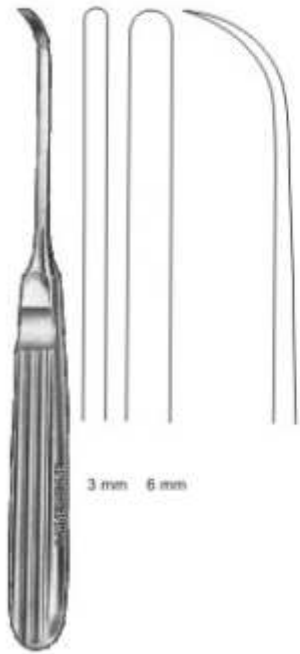

786-560 3 mm  
786-561 6 mm  
17 cm



786-562 8 mm  
Trelat  
14 cm



786-563  
König  
15.5 cm

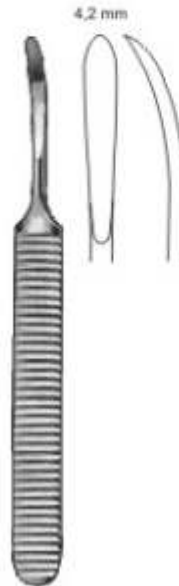

786-564  
Williger  
14 cm

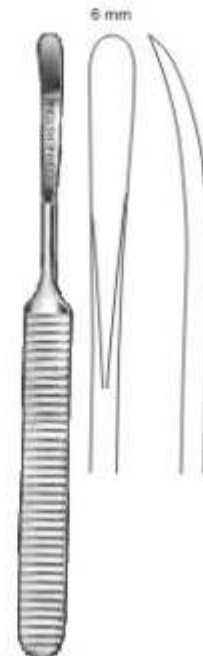

786-565  
Williger  
16 cm



786-567 6 mm  
786-568 8 mm

786-566 6 mm  
16.5 cm

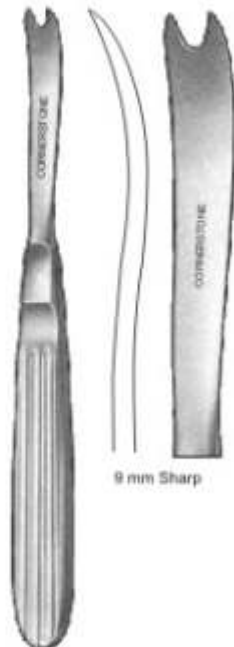

786-569  
Obwegeser  
17 cm

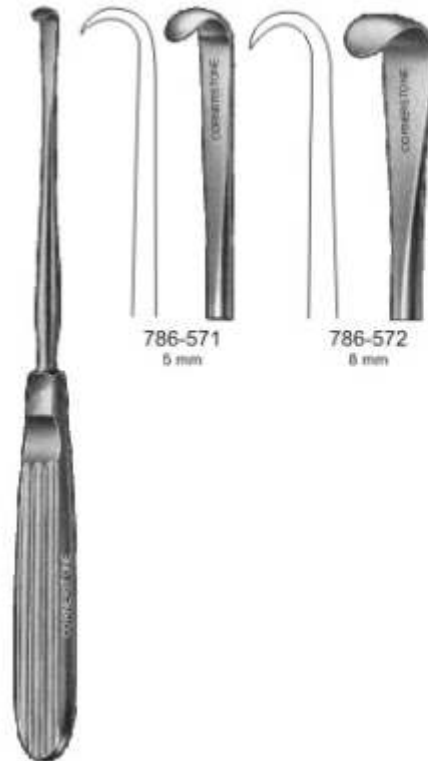

786-571  
5 mm

786-572  
5 mm

786-570  
5 mm  
20 cm



786-573  
Tessier  
22 cm

6 mm  
Bone Curette

# Elevators



786-574  
Scidin  
19,5 cm



786-575  
Scidin  
19,5 cm



786-576  
Champnet  
15 cm



786-577



786-578



786-579



786-580



786-581  
Freer  
16 cm



786-582  
Freer  
16 cm



786-583  
Partsch, mod  
14,5 cm



786-584  
Mead  
16,5 cm



786-585  
Mead  
18 cm

# Chisels & Gouges

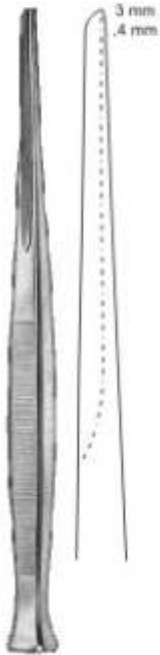

**786-586**  
Partsch  
17 cm



**786-587**  
Freer  
16 cm



**786-588**  
Freer  
16 cm



**786-589**  
Lucas  
16 cm



**786-590**  
Lucas  
16 cm



**786-591**  
Lambotte  
12.5 cm



**786-592**  
14 cm



**786-593**  
Partsch  
14 cm



**786-594**  
Partsch  
17 cm



**786-595**  
Partsch  
14 cm



# Rubber Dam Instruments

Clamp forceps



786-596  
Ivory lightweight  
17 cm



786-597  
Brewer  
17.5 cm



786-598  
Stoker  
17.5 cm

Punch forceps



786-599  
Ainsworth  
17 cm



786-600  
Ivory  
17 cm



Rubber Dam Frame  
786-601

# Tissue Pliers

786-602  
Fig.1  
Adson  
12 cm



786-603  
Fig.1  
Adson 1x2  
12 cm



786-604  
Fig.1  
Semken-Taylor  
12.5 cm



786-605  
Fig.2  
Semken-Taylor  
12.5 cm



786-606  
Fig.1  
Semken-Taylor 1x2  
12.5 cm



786-607  
Fig.2  
Semken-Taylor 1x2  
12.5 cm



786-608  
12 cm



786-609  
11.5 cm



786-610  
11.5 cm



786-611  
11.5 cm



# Cotton and Dressing Pliers

- Suture Plier

786-612  
15 cm

- Goldman-Fox  
(Crane-Kaplane)

786-613  
Fig.1  
15 cm

- Goldman-Fox  
(Crane-Kaplane)

786-614  
Fig.2  
15 cm

- Self-Locking

786-615  
Fig.1  
15 cm

- Self-Locking

786-616  
Fig.2  
15 cm

- Flagg

786-617  
Fig.1  
15 cm

- London College

786-618  
Fig.2  
15 cm

- Meriam

786-619  
Fig.3  
16 cm

- Perry

786-620  
Fig.4  
13 cm

- self-Locking

786-621  
Fig.18L  
16 cm

- College

786-622  
Fig.2  
16 cm

- College

786-623  
Fig.3  
16 cm



Mouth Mirrors  
Handles For Mouth Mirrors



786-624  
Plane 4  
22 mm  
Plane 5  
24 mm



786-625  
Magnifying 4  
22 mm  
Magnifying 5  
24 mm



786-626  
Plane 4  
22 mm  
Plane 5  
24 mm



786-627  
Magnifying 4  
22 mm  
Magnifying 5  
24 mm  
With cone-socket



786-628



786-629  
Hollow



786-630



786-631  
Hollow



# Scalpel Handles



786-632  
Fig. 3L



786-633  
Fig. 7



786-634  
Fig. 5



786-635  
Fig. 5A



786-636  
Fig. 3



786-637  
Fig. 3G



786-638  
Fig. 4

# Handles Reference Guide

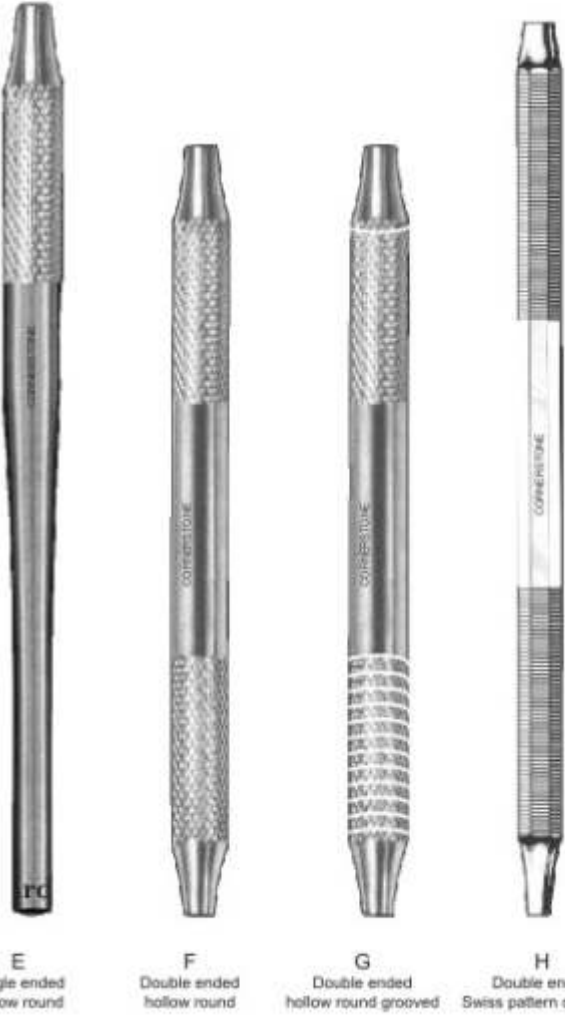

**Note:**  
 If you have preference different from the standard handle shown, please specify the optional handle number when ordering. If the tip/handle combination you desire is not shown, we will be glade to provide you with a quote for its preparation.

# Explorers Endodontic Instruments



786-639  
Fig.23



786-640  
Fig.2



786-641  
Fig.16



786-642  
Fig.9



786-643  
Fig.10



786-644  
Fig.12



786-645  
Fig.11



786-646  
Fig.6



786-647  
Fig.8



786-648  
Fig.5



786-649  
Fig.17



786-650  
Fig.17A



786-651  
Fig.3



786-652  
Fig.3A

58



786-653  
Fig.1  
Spreader



786-654  
Fig.2  
Spreader



786-655  
Fig.3  
Spreader



786-656  
Fig.4  
Spreader



786-657  
Fig.5  
Spreader



786-658  
Fig.6  
Spreader



786-659  
Fig.7  
Spreader

Periodontal pocket probes  
Endodontic Instruments



786-660  
Williams



786-660 Williams    786-661 Merrill A    786-662 Merrill B    786-663 Goldman Fox    786-664 University of Michigan    786-665 26 G

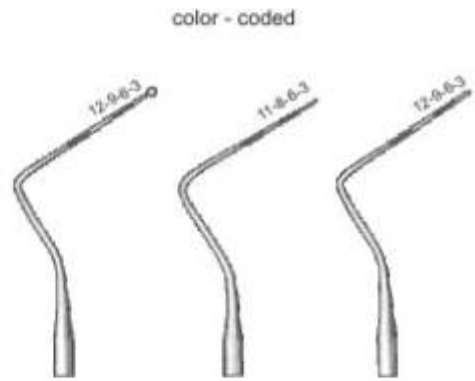

786-666 CP-12S O.M.S    786-667 CP-11    786-668 CP-12



786-669 Fig.1 Luks    786-670 Fig.2 Luks    786-671 Fig.3 Luks    786-672 Fig.4 Luks

root-canal pluggers

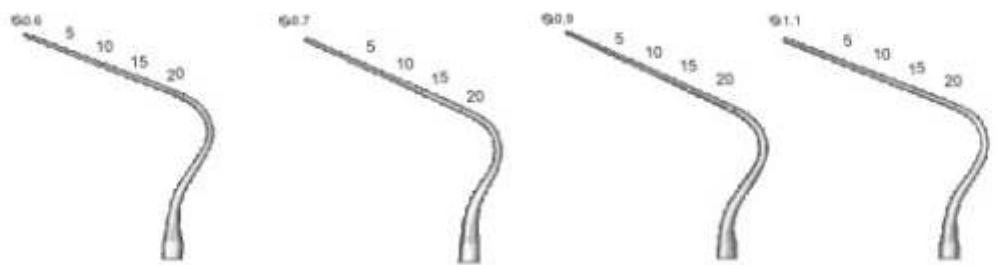

786-673 Fig. 1 vertical condenser    786-674 Fig. 2 vertical condenser    786-675 Fig. 3 vertical condenser    786-676 Fig. 4 vertical condenser

# Explorers Probes

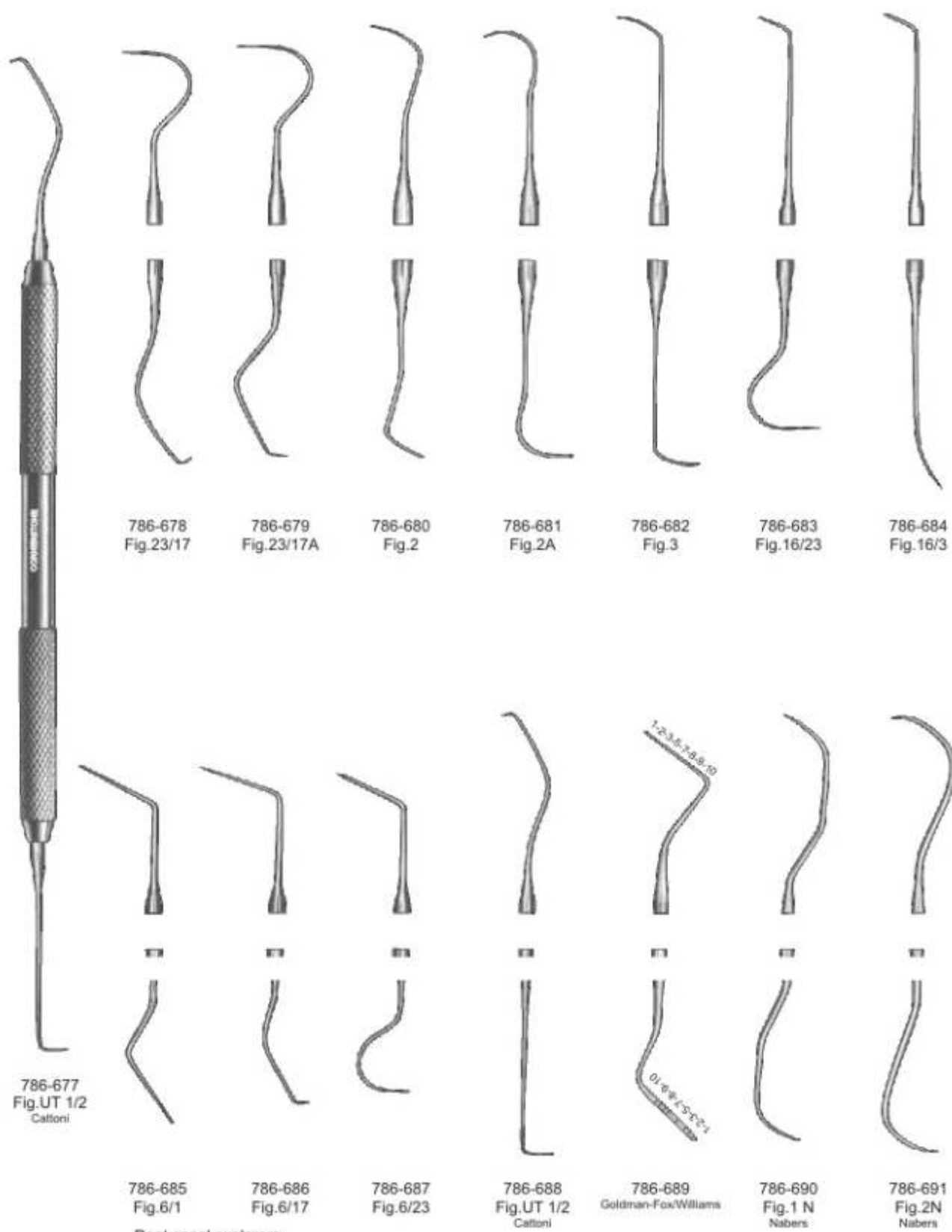

786-678  
Fig.23/17

786-679  
Fig.23/17A

786-680  
Fig.2

786-681  
Fig.2A

786-682  
Fig.3

786-683  
Fig.16/23

786-684  
Fig.16/3

786-677  
Fig.UT 1/2  
Calloni

786-685  
Fig.6/1

786-686  
Fig.6/17

786-687  
Fig.6/23

786-688  
Fig.UT 1/2  
Calloni

786-689  
Goldman-Fox/Williams

786-690  
Fig.1 N  
Nabers

786-691  
Fig.2N  
Nabers

Root canal explorers



# Explorers

## Endodontic Instruments

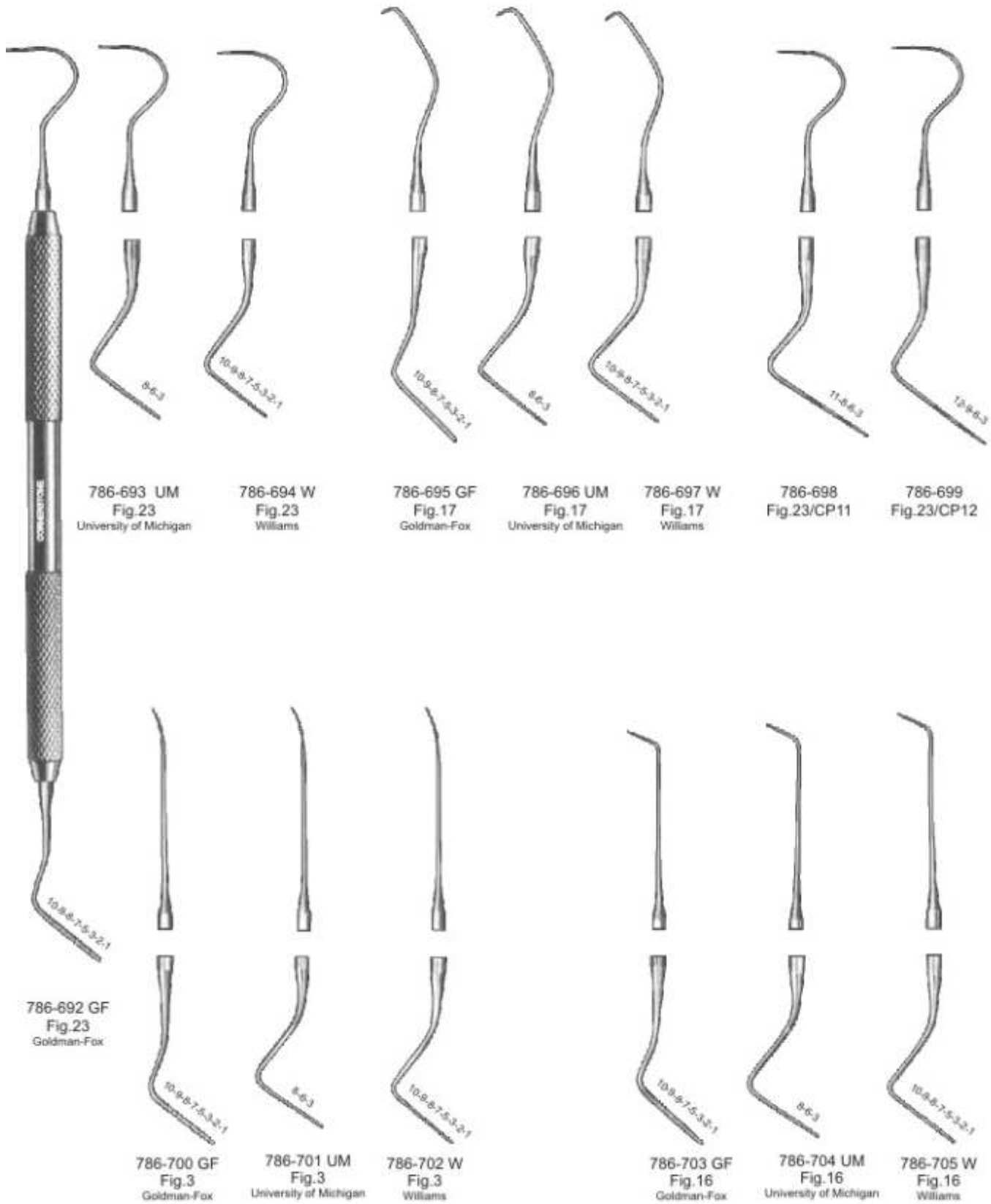

# Filling Instruments

amalgam instruments

serrated



786-706  
Fig.1



786-707  
Fig.2



786-708  
Fig.3



786-709  
Fig.4



786-710  
Fig.5



786-711  
Fig.1



786-712  
Fig.2



786-713  
Fig.3



smooth



786-714  
Fig.1L



786-715  
Fig.2L



786-716  
Fig.3L



786-717  
Fig.1



786-718  
Fig.2



786-719  
Fig.3

# Filling Instruments

amalgam instruments

serrated

smooth

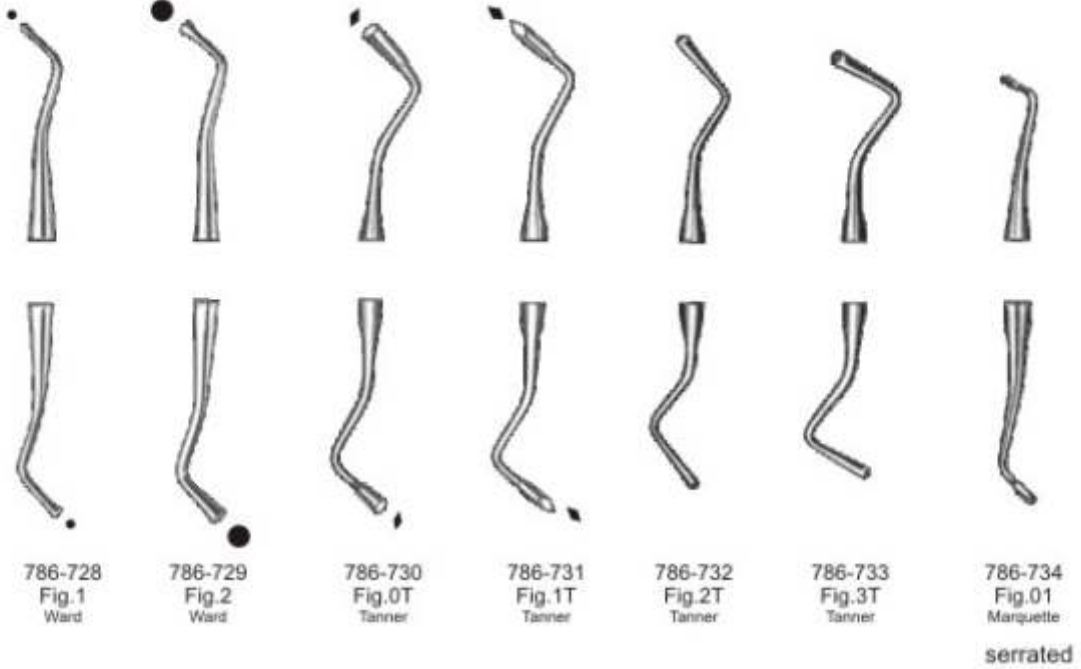
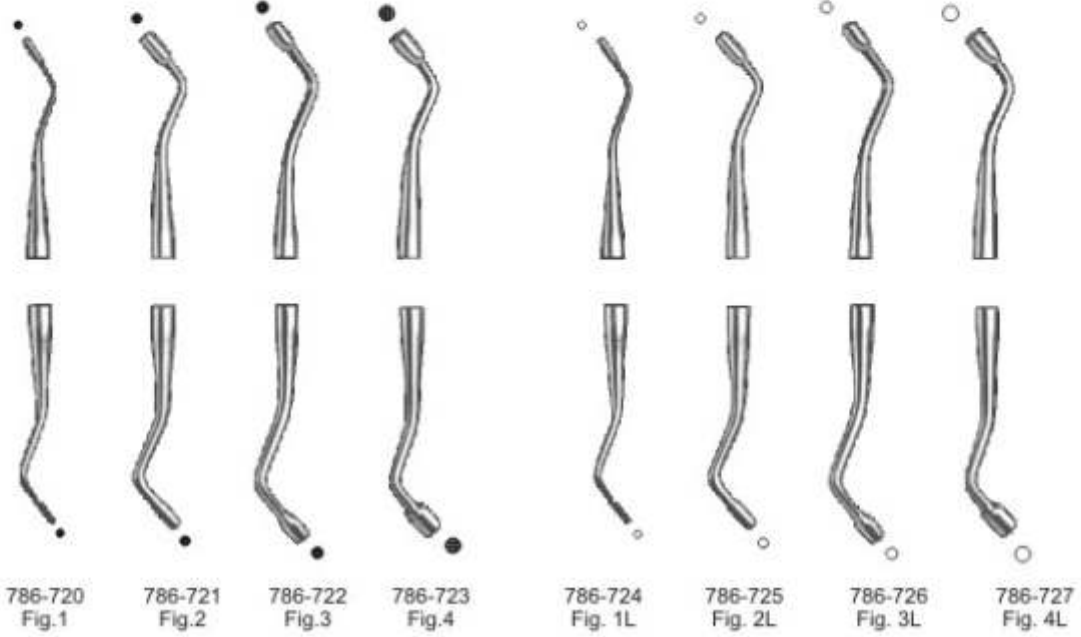

# Filling Instruments

amalgam instruments

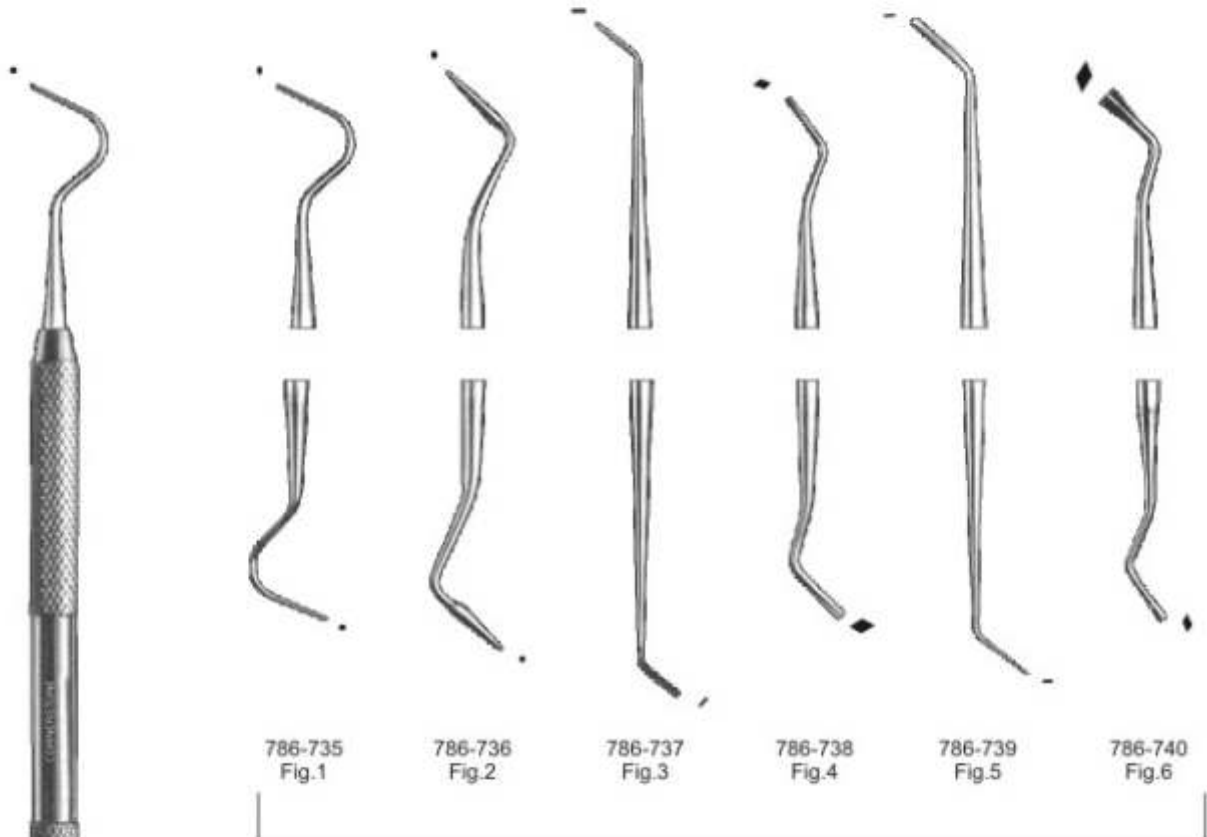

set of 6 pieces

64

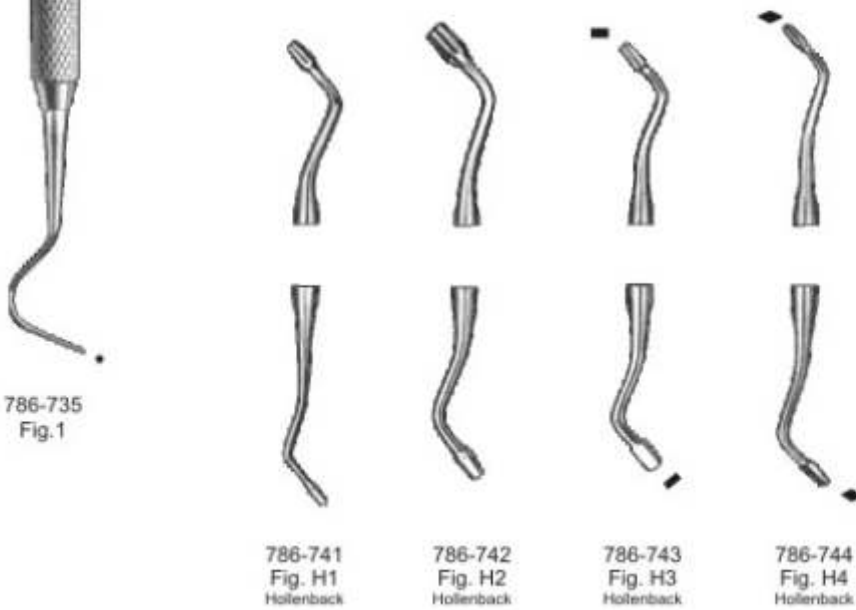

# Filling Instruments Plastic Filling Instruments

Burnishers

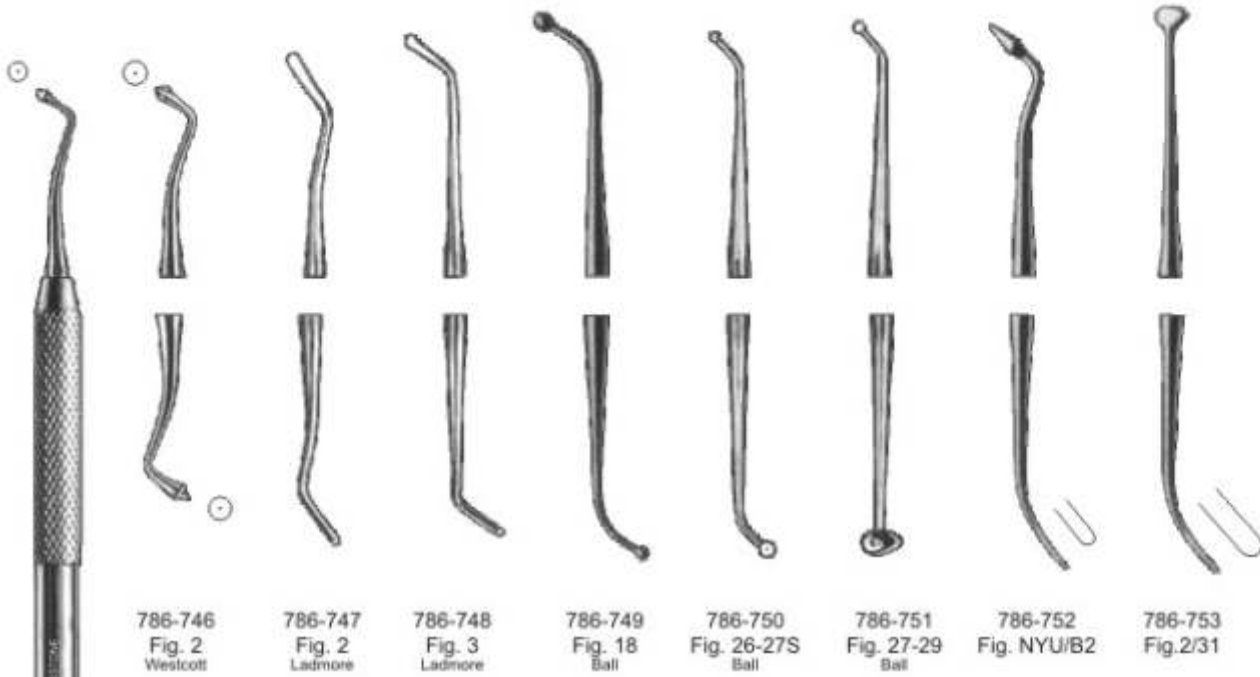

plastic filling instruments

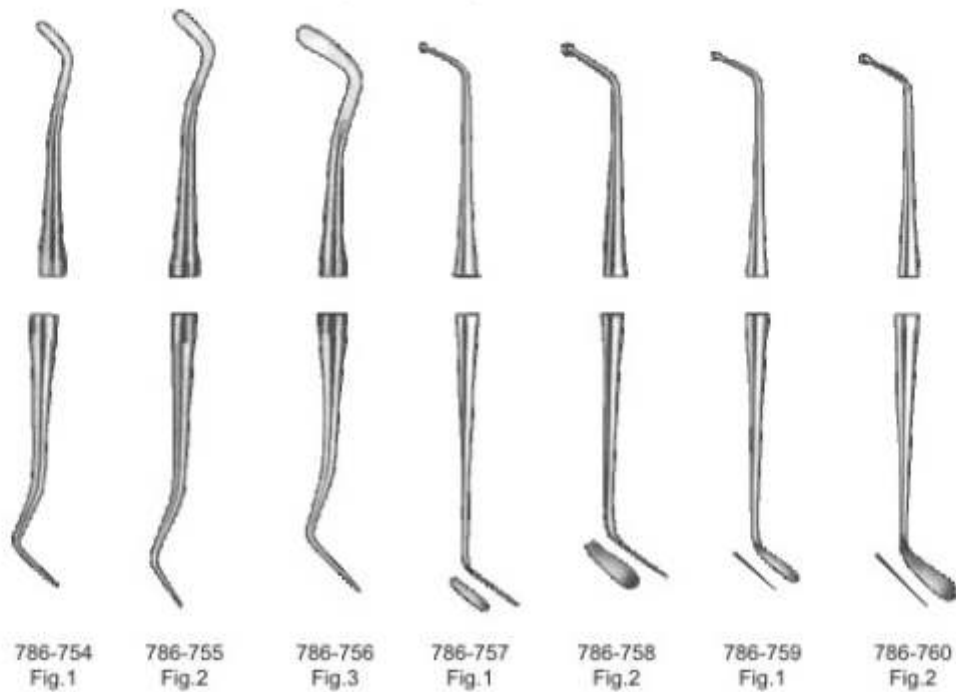

786-745  
Fig. 1  
Westcott



**Plastic Filling Instruments**  
**Amalgam Carvers**

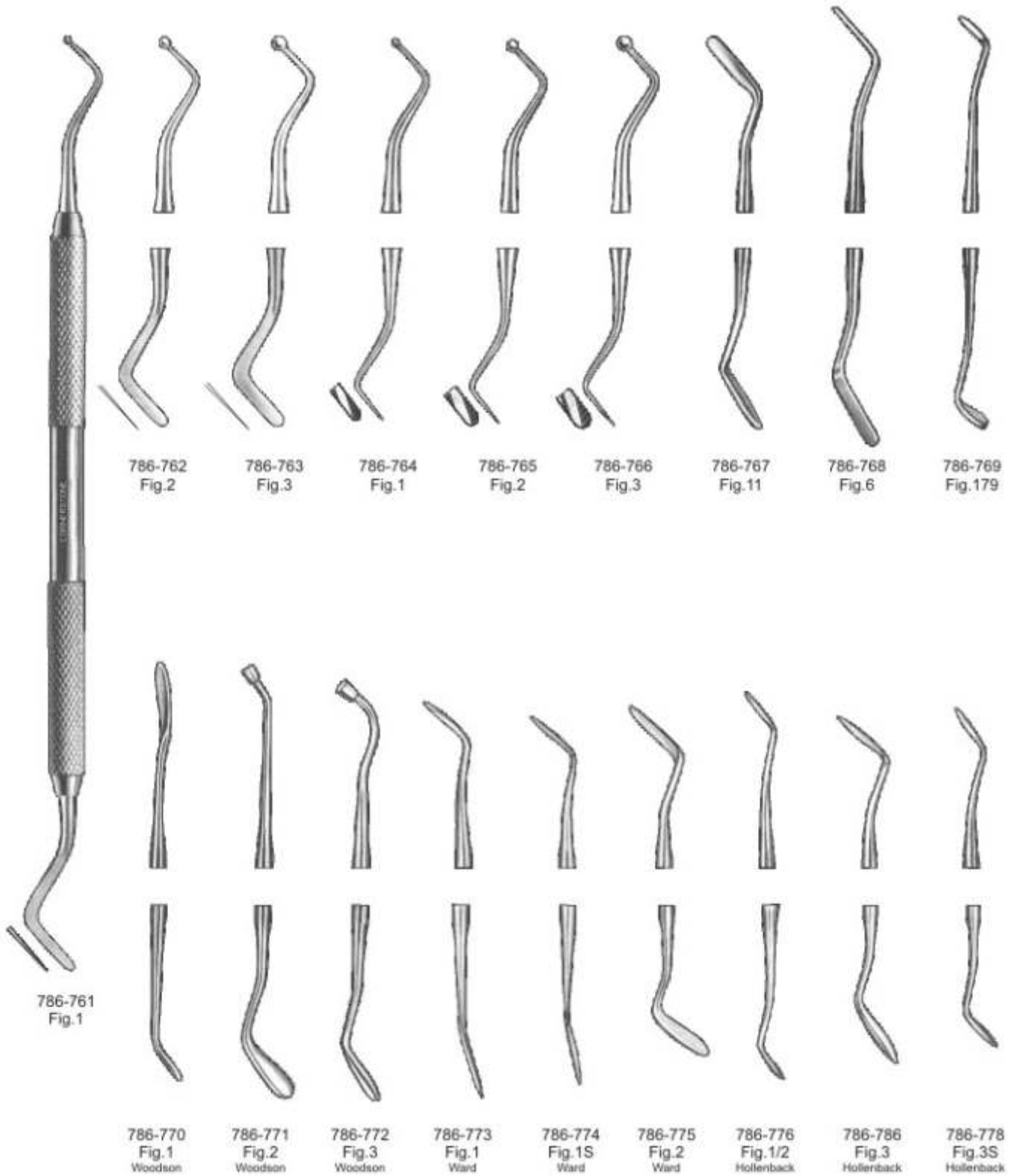

# Amalgam Carvers Operative Instruments



786-779  
Fig.1  
Farhen

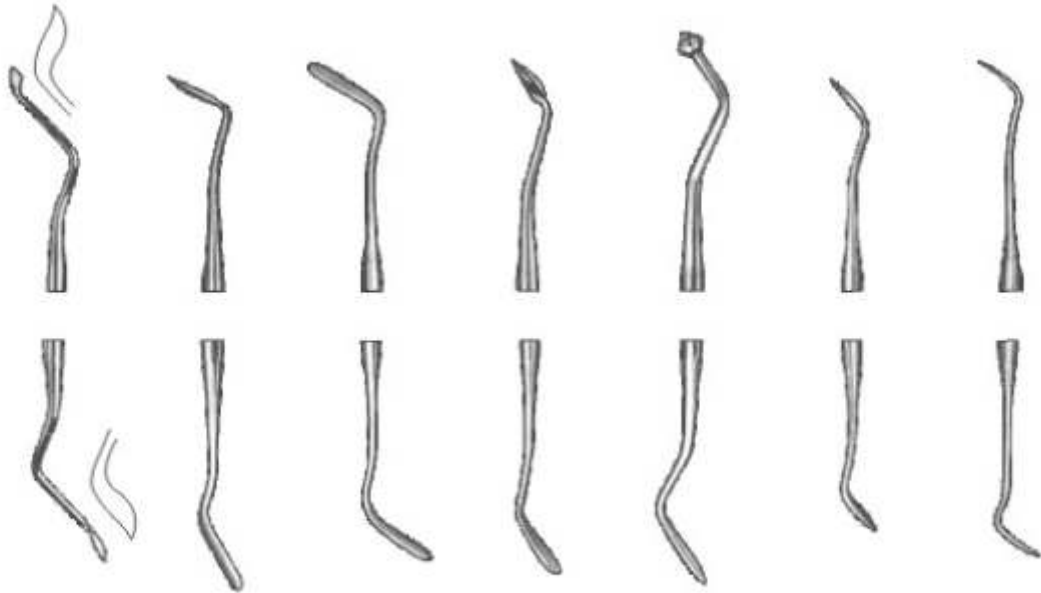

786-780 Fig.2 USC	786-781 Fig.1 Interproximal	786-782 Fig.2 Interproximal Off-Angle	786-783 Fig.SHO-A	786-784 Fig.3-SHO	786-785 Fig.104	786-786 Fig.8 Wiland
-------------------------	-----------------------------------	--	----------------------	----------------------	--------------------	----------------------------

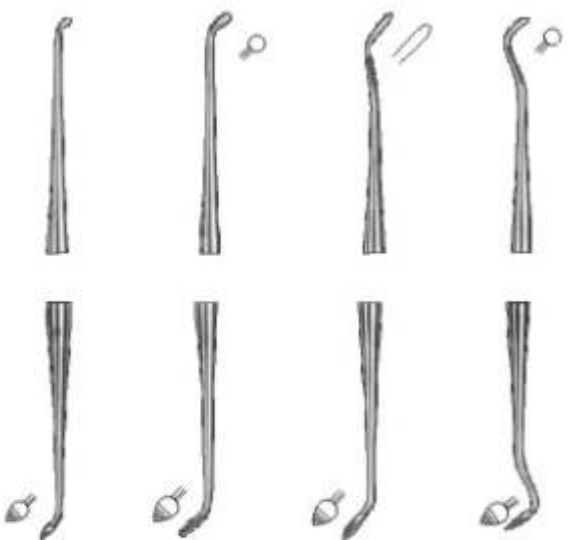

786-787 Fig.1	786-788 Fig.2	786-789 Fig.3	786-790 Fig.4
------------------	------------------	------------------	------------------

cleoids-discoids

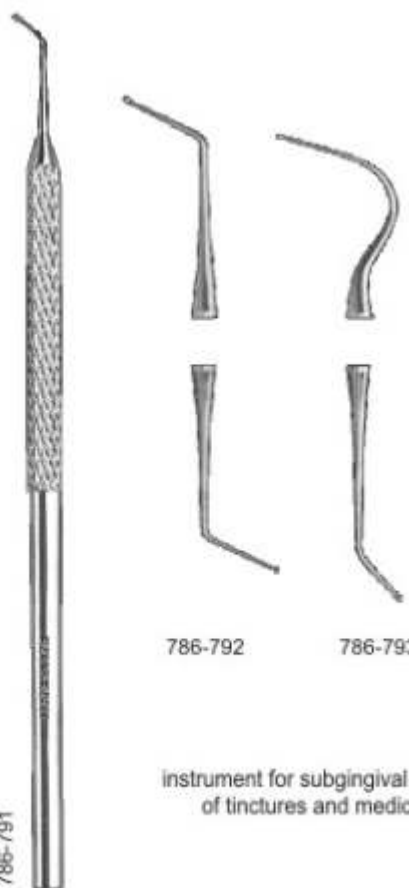

786-791

instrument for subgingival application  
of tinctures and medicaments

# Cavity Preparation Instruments

gingival margin trimmers

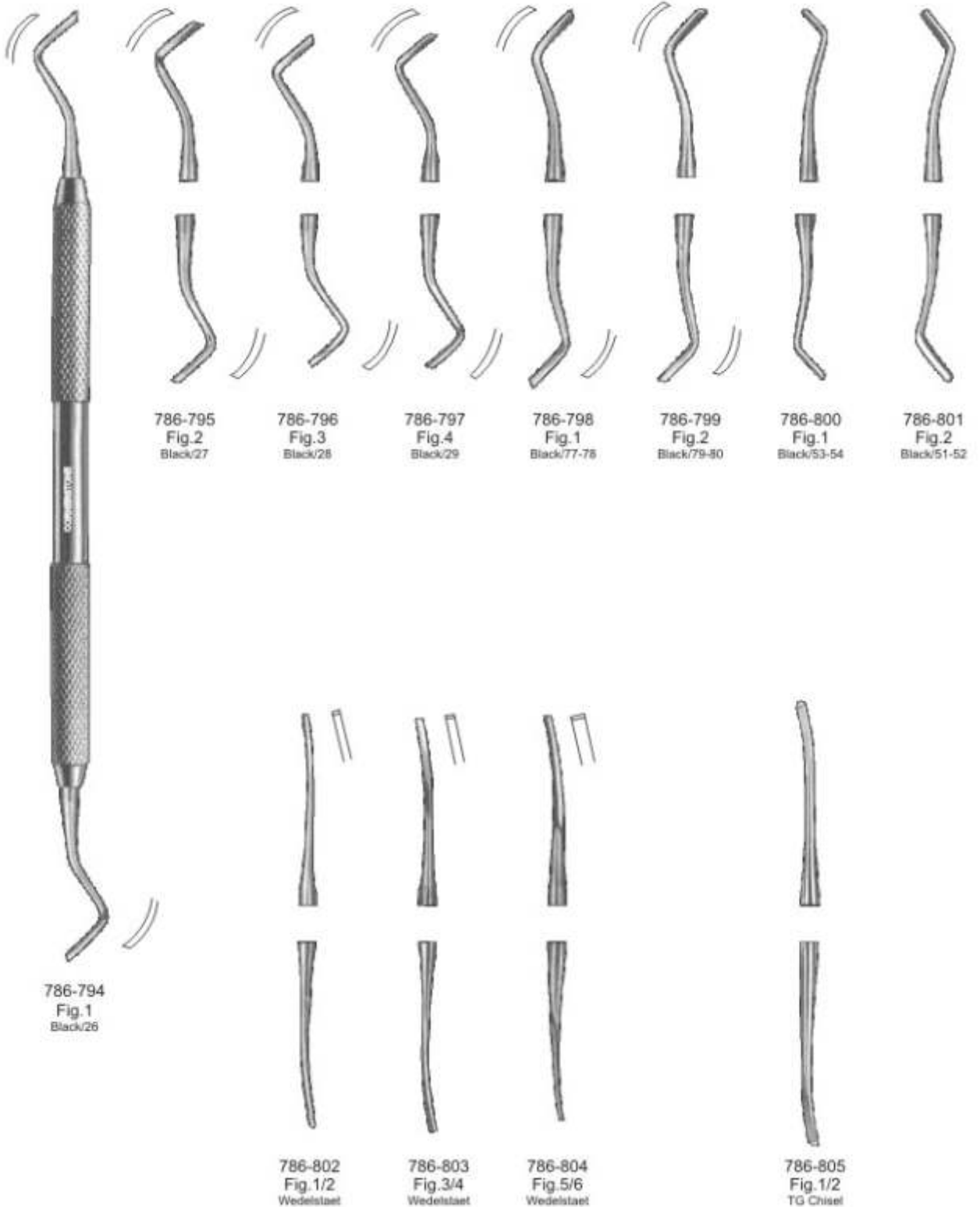

# Excavators



786-806  
Fig. 6

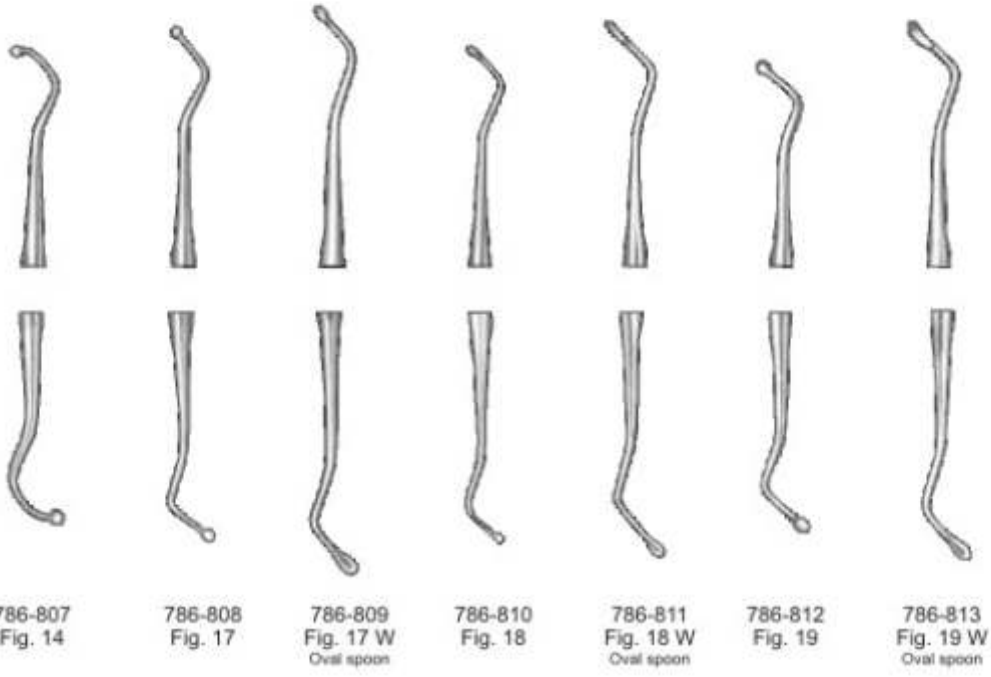

786-807  
Fig. 14

786-808  
Fig. 17

786-809  
Fig. 17 W  
Oval spoon

786-810  
Fig. 18

786-811  
Fig. 18 W  
Oval spoon

786-812  
Fig. 19

786-813  
Fig. 19 W  
Oval spoon

025-175cs Set of 5

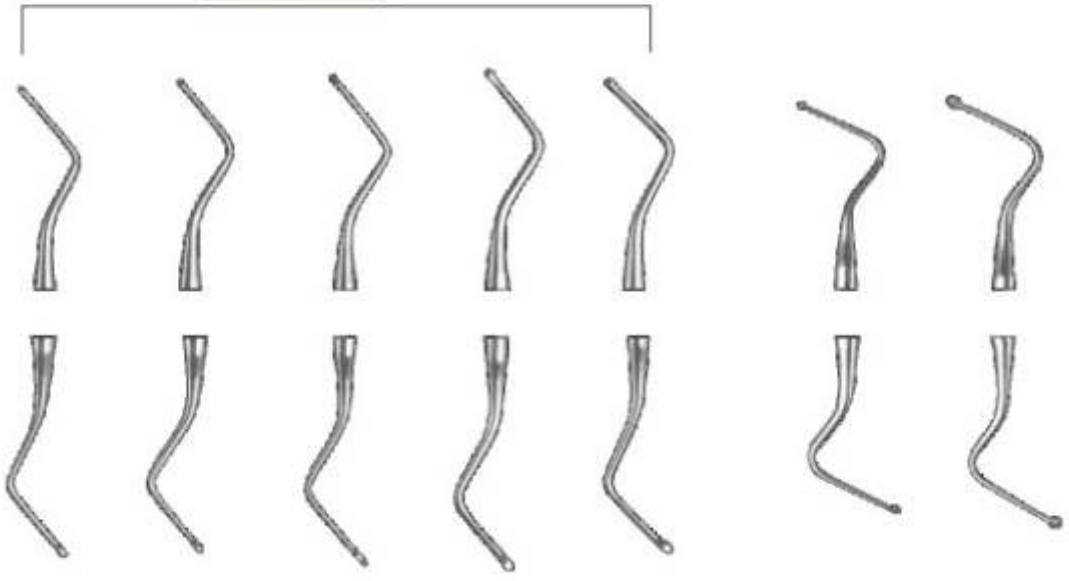

786-814  
Fig. 0

786-815  
Fig. 1

786-816  
Fig. 2

786-817  
Fig. 3

786-818  
Fig. 4

786-819  
Fig. 1

786-820  
Fig. 2

# Excavators

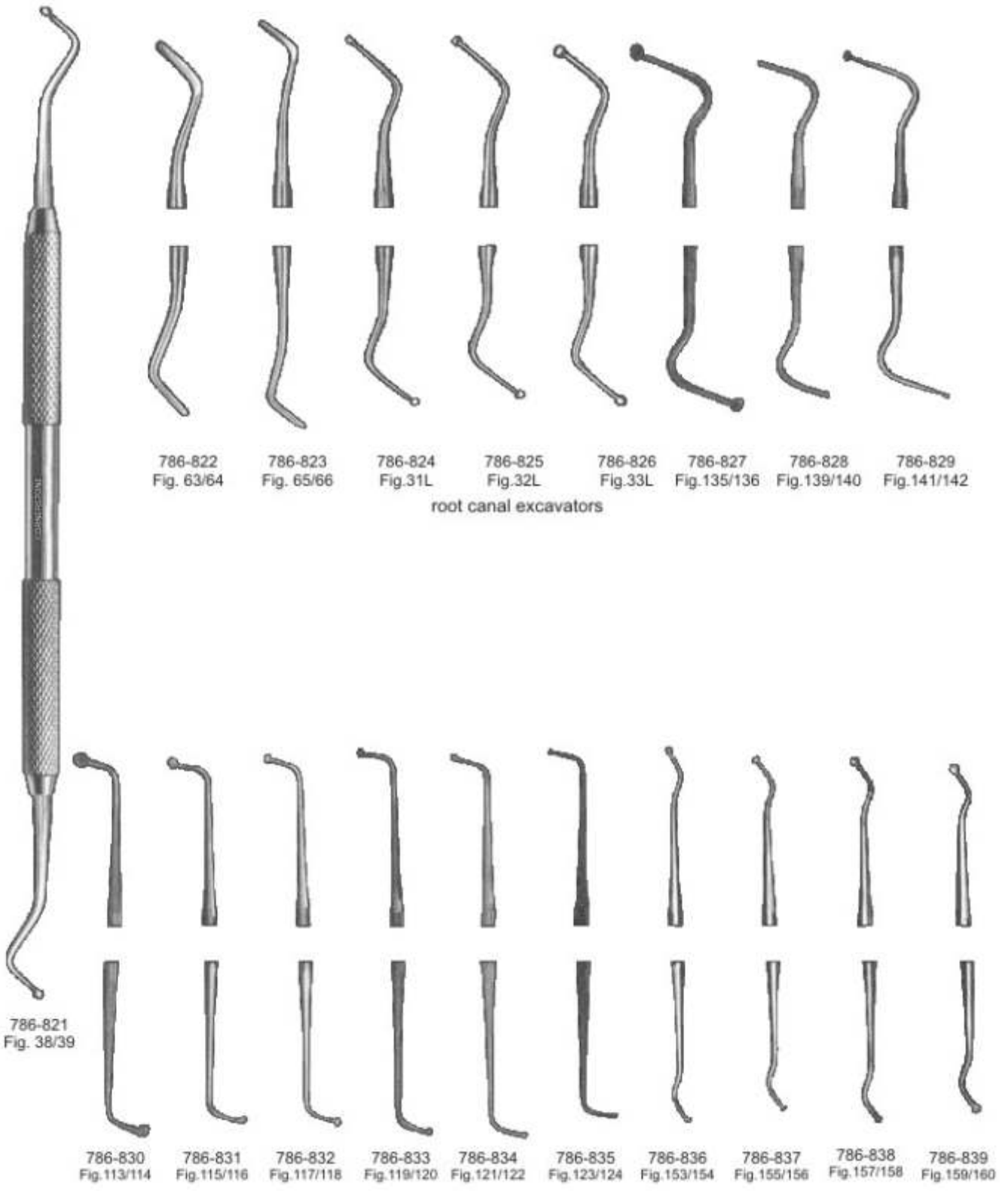

786-822 Fig. 63/64    786-823 Fig. 65/66    786-824 Fig. 31L    786-825 Fig. 32L    786-826 Fig. 33L    786-827 Fig. 135/136    786-828 Fig. 139/140    786-829 Fig. 141/142

root canal excavators

70

786-821 Fig. 38/39

786-830 Fig. 113/114    786-831 Fig. 115/116    786-832 Fig. 117/118    786-833 Fig. 119/120    786-834 Fig. 121/122    786-835 Fig. 123/124    786-836 Fig. 153/154    786-837 Fig. 155/156    786-838 Fig. 157/158    786-839 Fig. 159/160



Excavators  
English Pattern

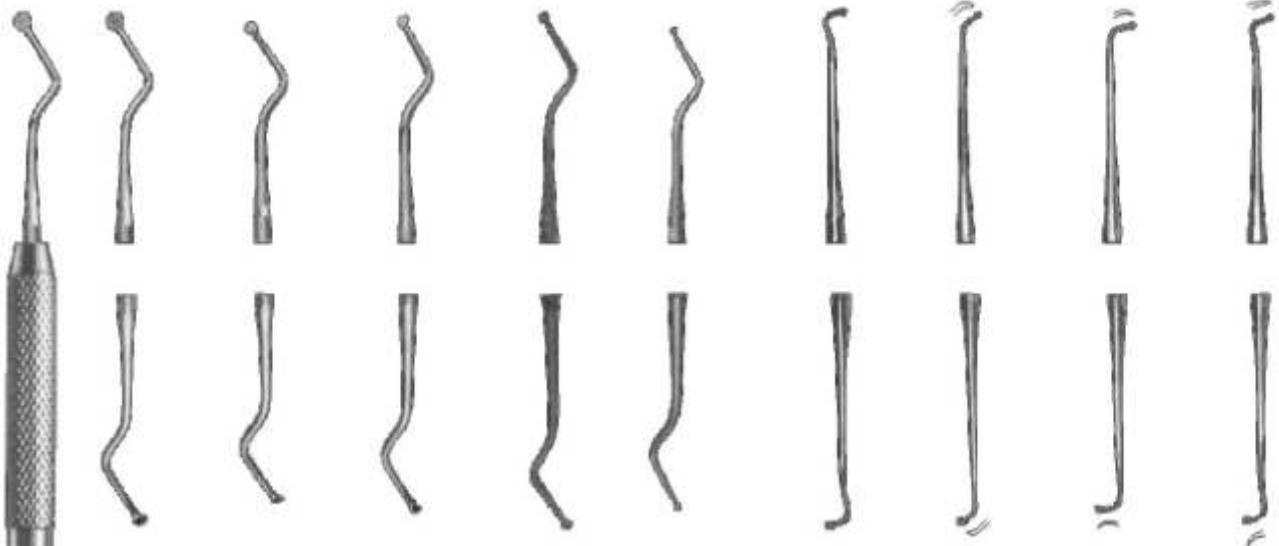

786-840 Fig. 125/126    786-841 Fig. 127/128    786-842 Fig. 129/130    786-843 Fig. 131/132    786-844 Fig. 133/134    786-845 Fig. 9/10    786-846 Fig. 204/205    786-847 Fig. 206/207    786-848 Fig. 208/209

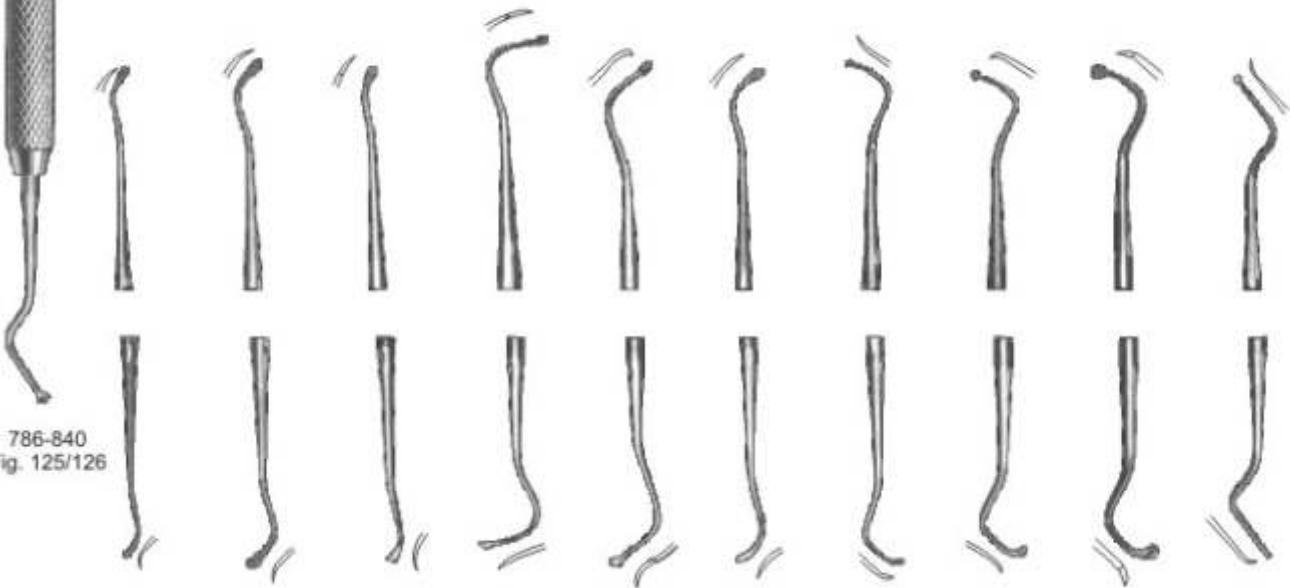

786-840  
Fig. 125/126

786-849 Fig. 210/211    786-850 Fig. 212/213    786-851 Fig. 214/215    786-852 Fig. 216/217    786-853 Fig. 218/219    786-854 Fig. 220/221    786-855 Fig. 243    786-856 Fig. 244    786-857 Fig. 245    786-858 Fig. 246

# Periodontia Instruments

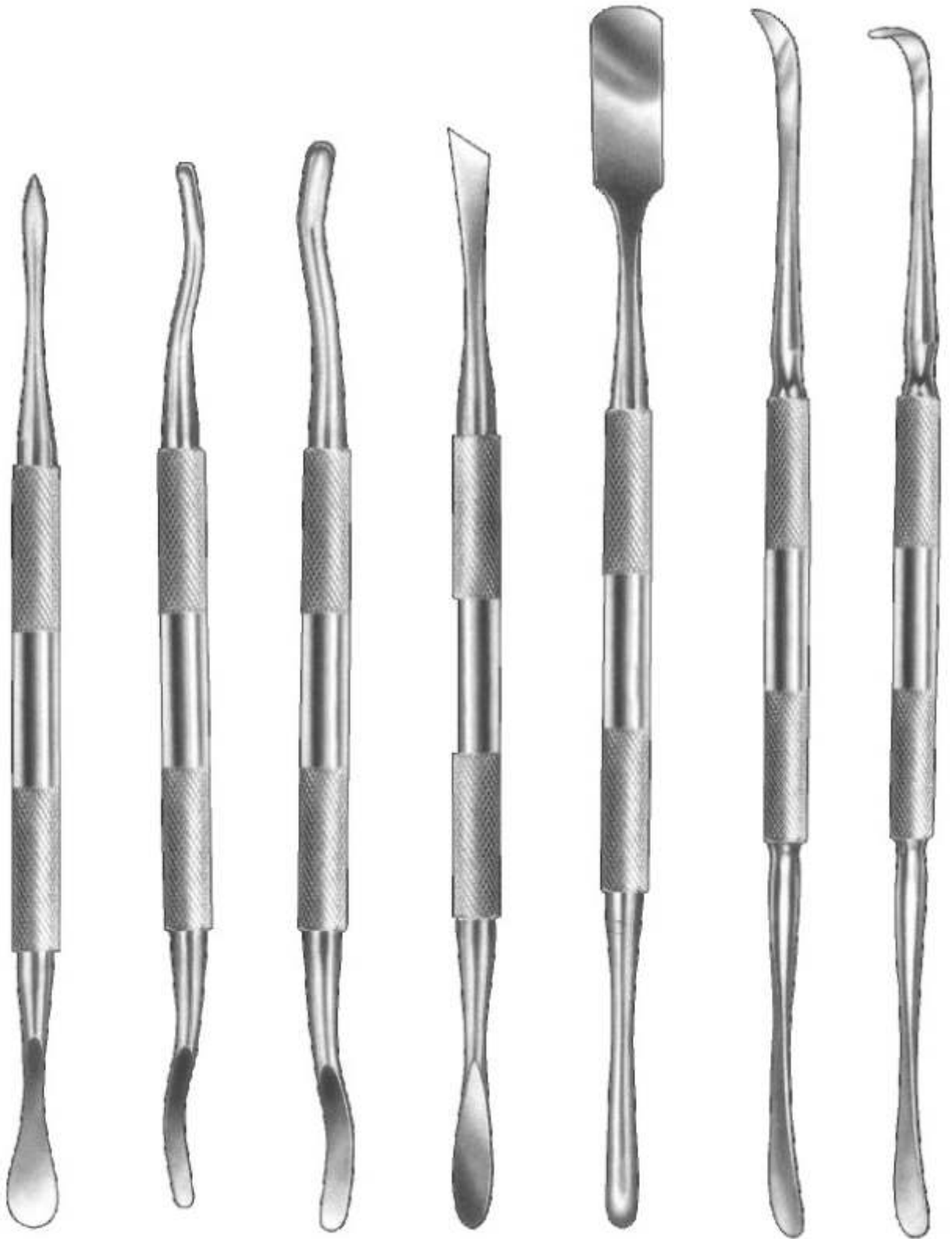

786-859  
Fig. M9  
Molt

786-860  
Fig. 1  
Hopkins

786-861  
Fig. 2  
Hopkins

786-862  
Fig. 3  
Mead

786-863  
Fig. PR3  
Prichard

786-864  
Fig. 15  
Freer

786-865  
Fig. 16  
Freer

Bone Files

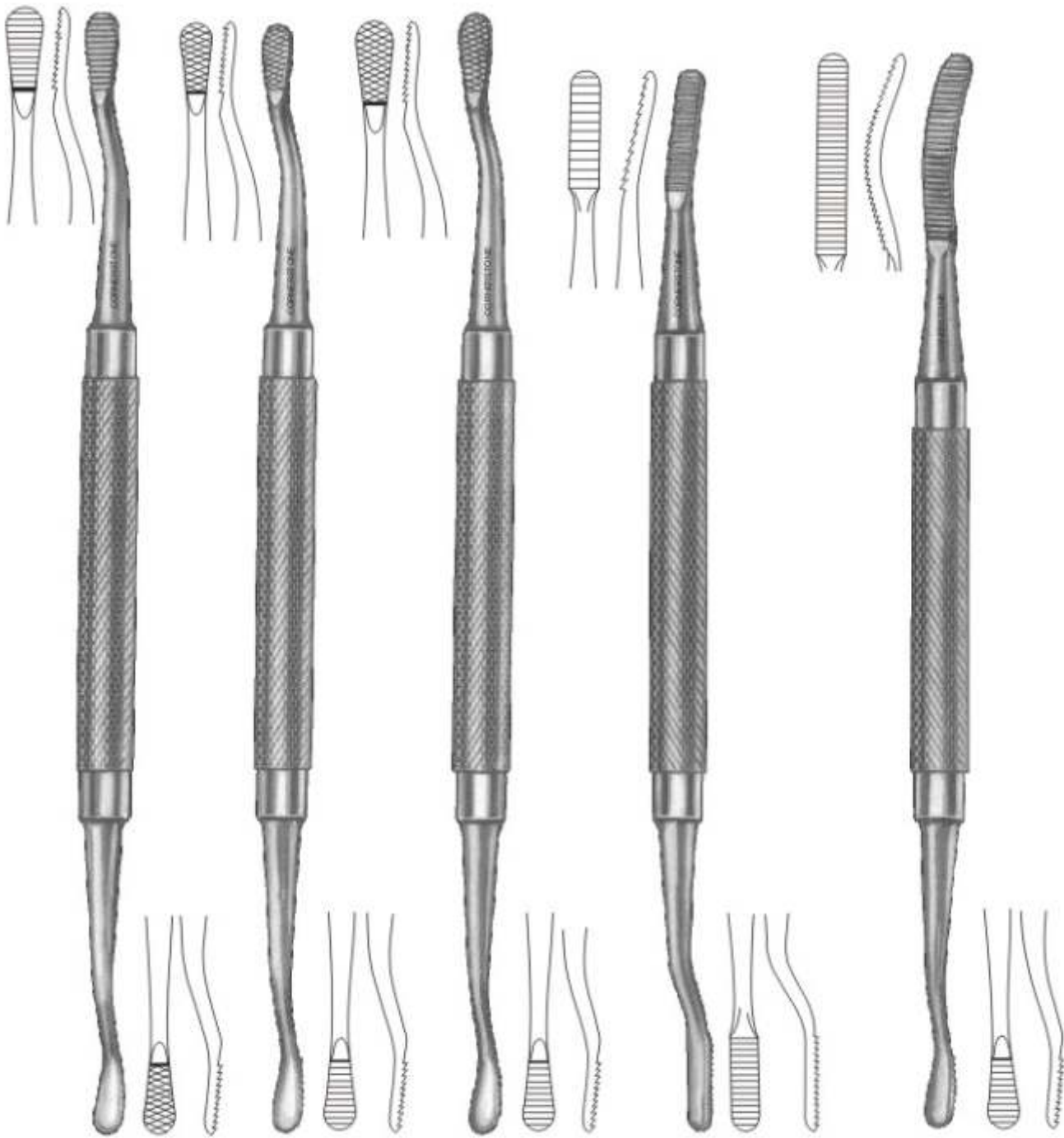

786-866  
Fig.12 CA

786-867  
Fig.12 A

786-868  
Fig.12  
Howard

786-869  
Fig.33

786-870  
Fig.45  
Miller

# Bone Files

74



786-871  
Fig.1  
Wahl



786-872  
Fig.2  
Wahl

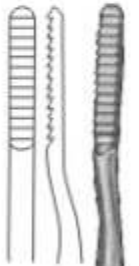

786-873  
Fig.1  
Polakoff



786-874  
Fig.64  
Miller

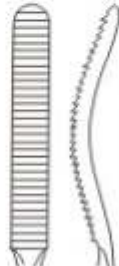

786-875  
Fig.10



# Bone Currettes Periodontia Instruments



786-877 Fig.2 Hemingway      786-878 Fig.3 Hemingway      786-879 Fig.4 Hemingway      786-880 Fig.85 Lucas      786-881 Fig.86 Lucas      786-882 Fig.87 Lucas      786-883 Fig.88 Lucas

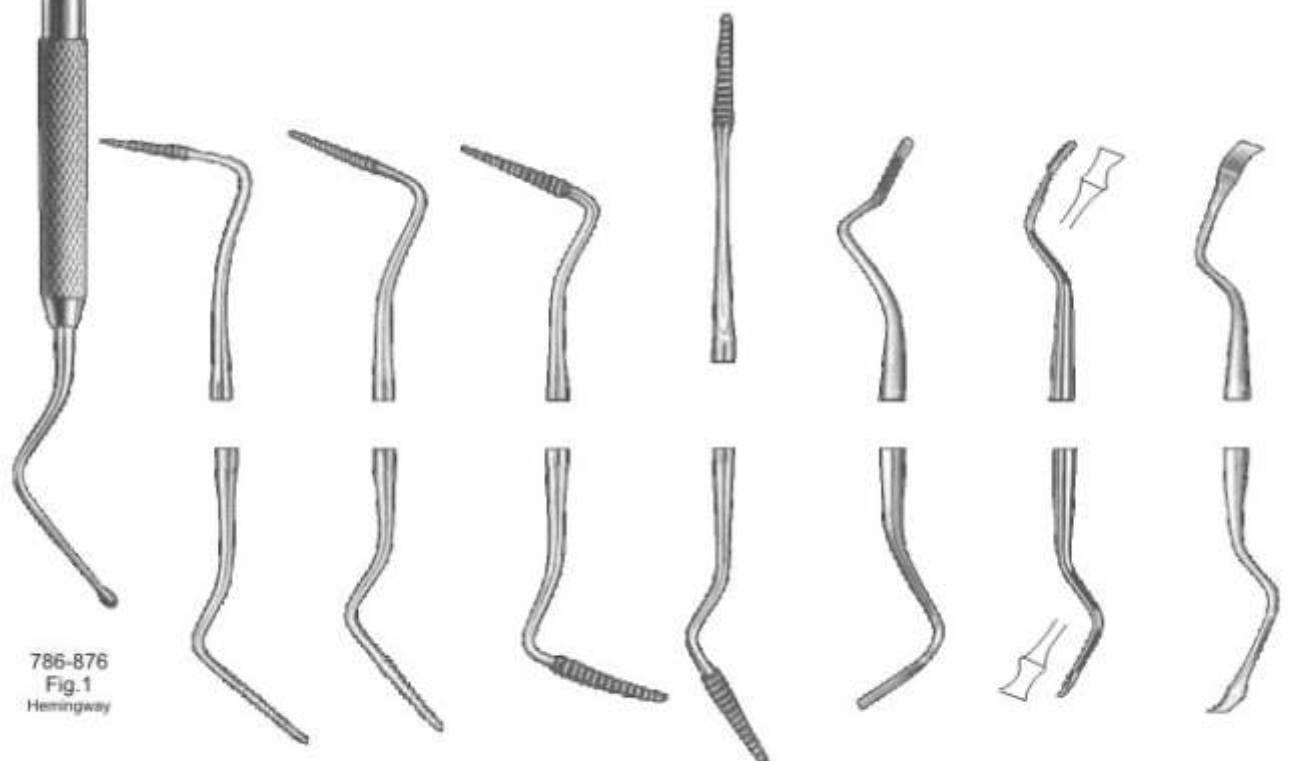

786-876 Fig.1 Hemingway

786-884 Fig.1S/2S Sugaman      786-885 Fig.3S/4S Sugaman      786-886 Fig.9/10 Schluger      786-887 Fig.11/12 Buck      786-888 Fig.3 Ochsenbein      786-889 Fig.4 Ochsenbein      786-890 Fig.36/37 Rhodes Back-Action



# Periodontia Instruments



786-891  
Fig.7  
Goldman-Fox

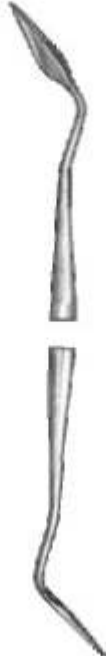

786-892  
Fig.8  
Goldman-Fox



786-893  
Fig.9  
Goldman-Fox

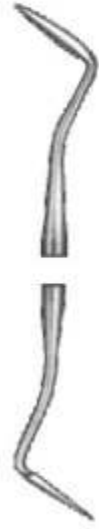

786-894  
Fig.11  
Goldman-Fox



786-895  
Fig.3/4  
Buck



786-896  
Fig.5/6  
Buck



786-897  
Fig.1/2  
(15k/16k)  
Kirkland



786-898  
Fig.1/2  
Crabn



786-899  
Fig.1/2  
Sanders



786-900  
Fig.4/5  
Sanders



786-901  
Fig.19/20  
(University of South California)  
USC Towner



786-902  
Fig.CK3  
Crane-Kaplan

# Periodontia Instruments

curettes and scalers

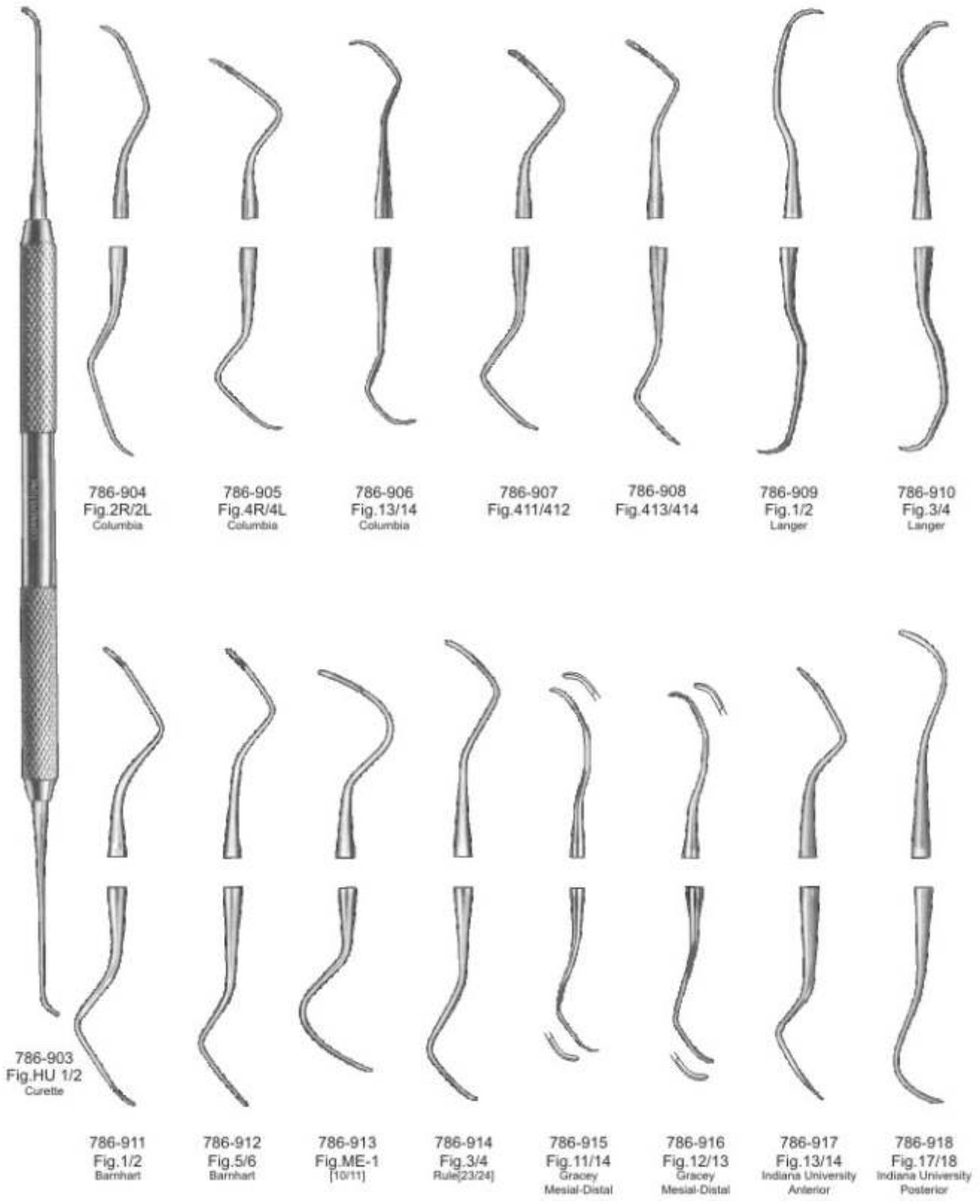

# Periodontia Instruments Gracey Curettes

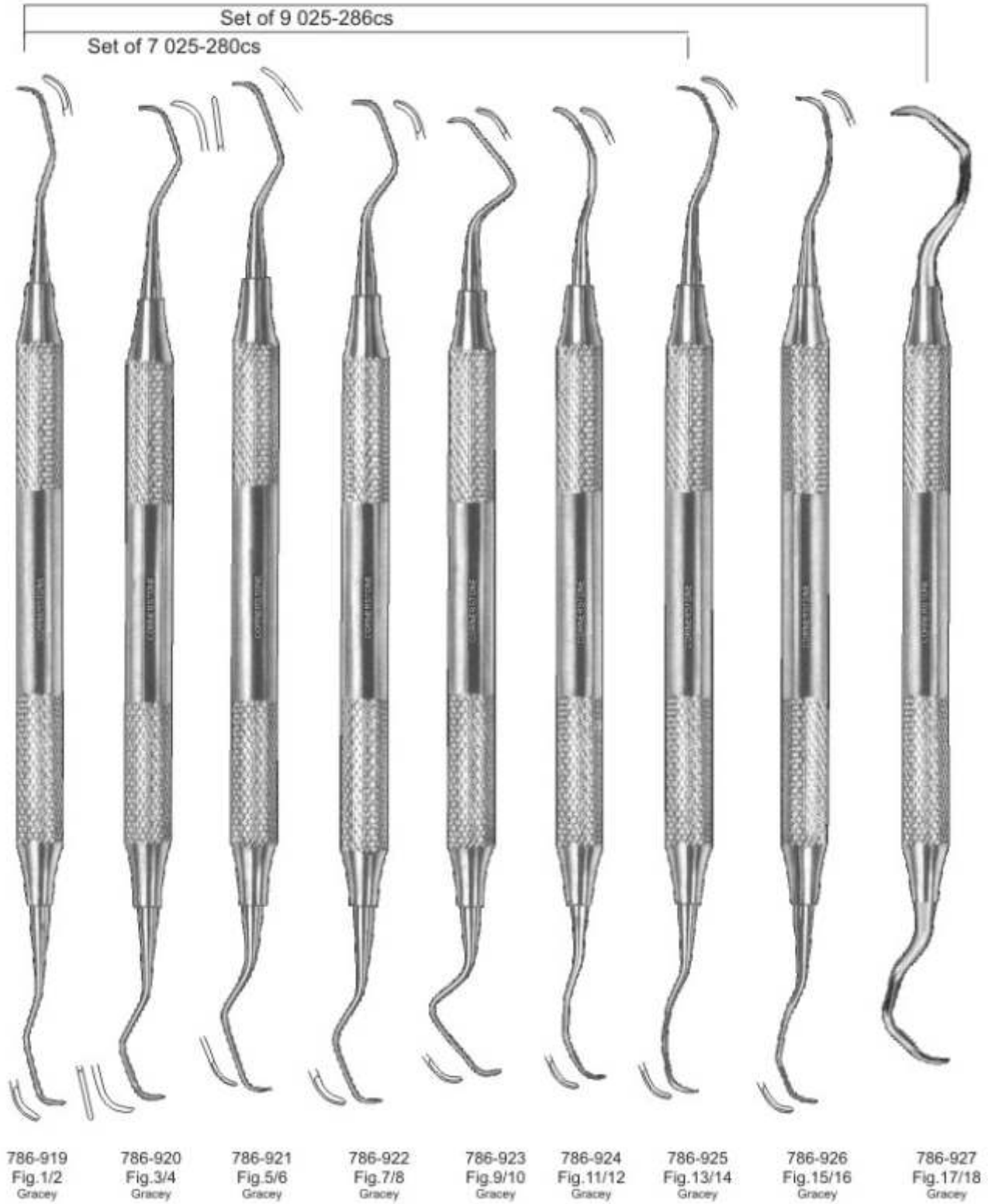

Gracey Curettes are also available in rigid points

# Periodontia Instruments

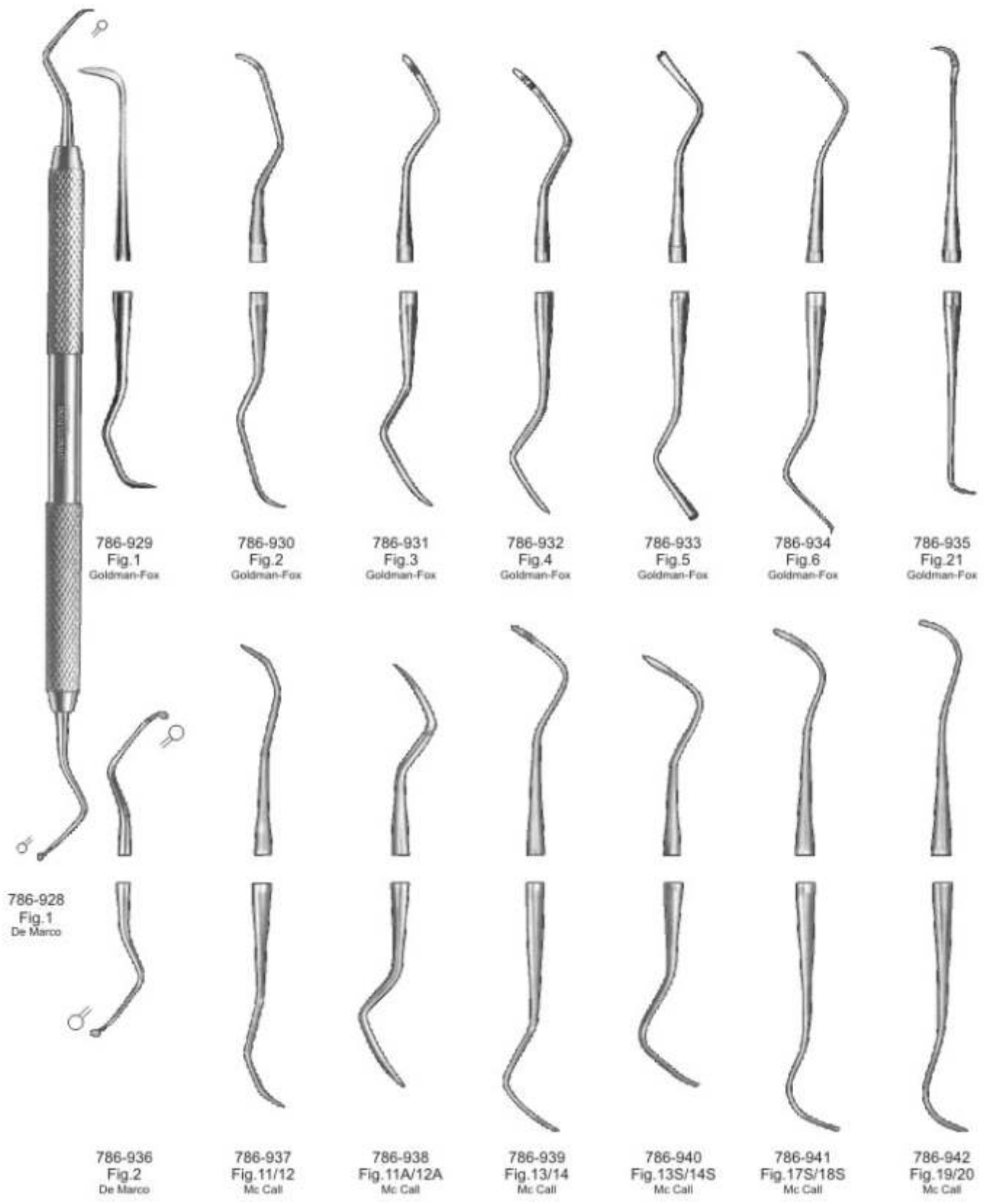

# Periodontia Instruments

## Scalers

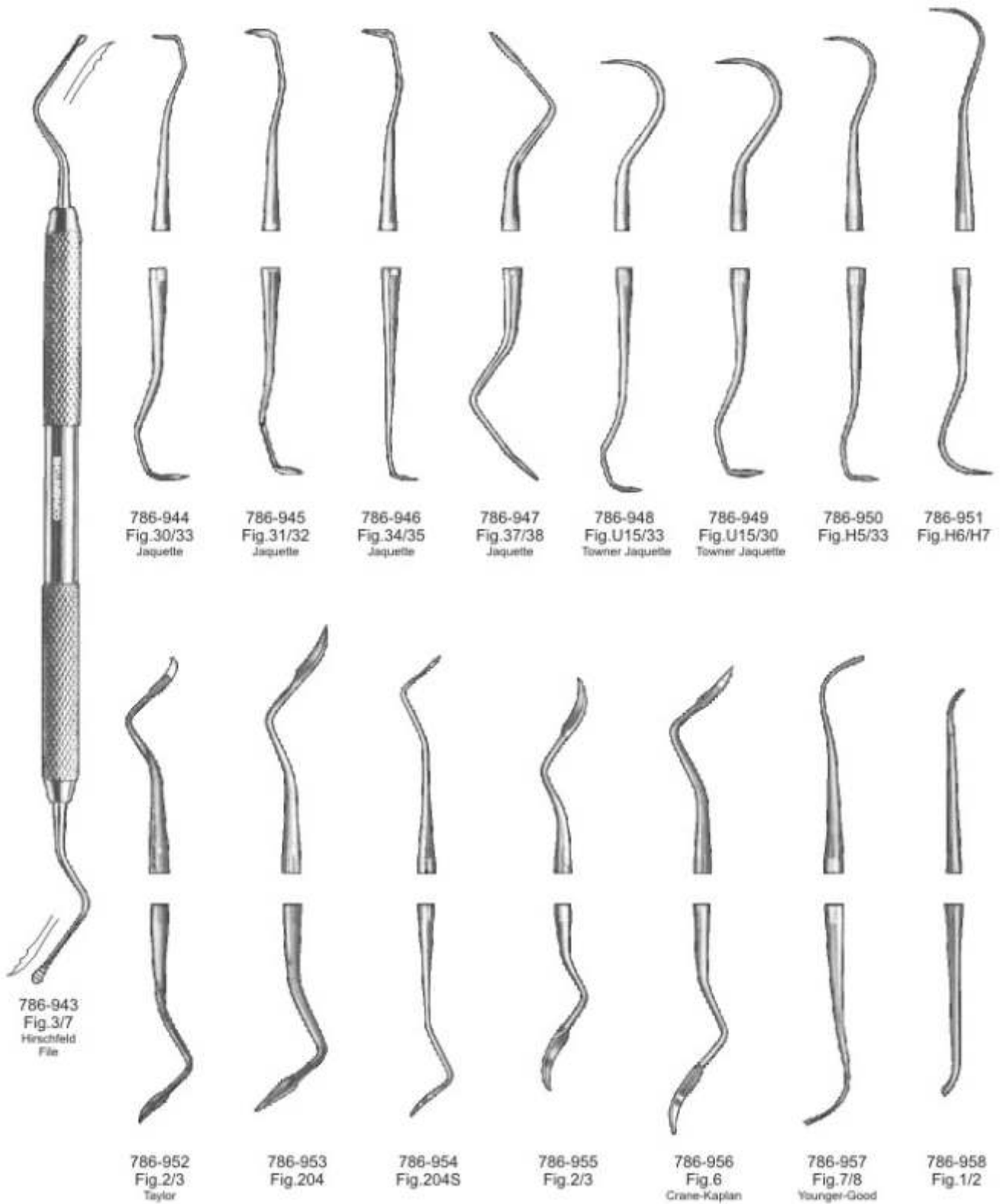



# Periodontia Instruments Scalers



786-959  
Fig.33



786-960  
Fig.31



786-961  
Fig.32



786-962  
Fig.34



786-963  
Fig.35



786-964  
Fig.H5  
Hygienist



786-965  
Fig.H6  
Hygienist



786-966  
Fig.H7  
Hygienist

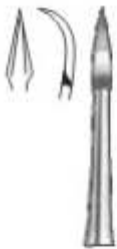

786-967  
Fig.1



786-968  
Fig.1L  
(sinistro)



786-969  
Fig.1R  
(destro)



786-970  
Fig.2L  
(sinistro)



786-971  
Fig.2R  
(destro)



786-972  
Fig.U15  
Toener



786-973  
Zerfing-Chisel

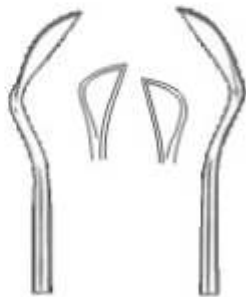

786-974  
Fig.1  
(15K)  
Kirkland



786-975  
Fig.2  
(16K)  
Kirkland



786-976  
Fig.1  
Orban



786-977  
Fig.2  
Orban



786-978  
Fig.1  
TG Chisel



786-979  
Fig.2  
TG Chisel

Cement Spatulas  
Heidemann Separating Spatulas



# Wax and Modelling Carvers

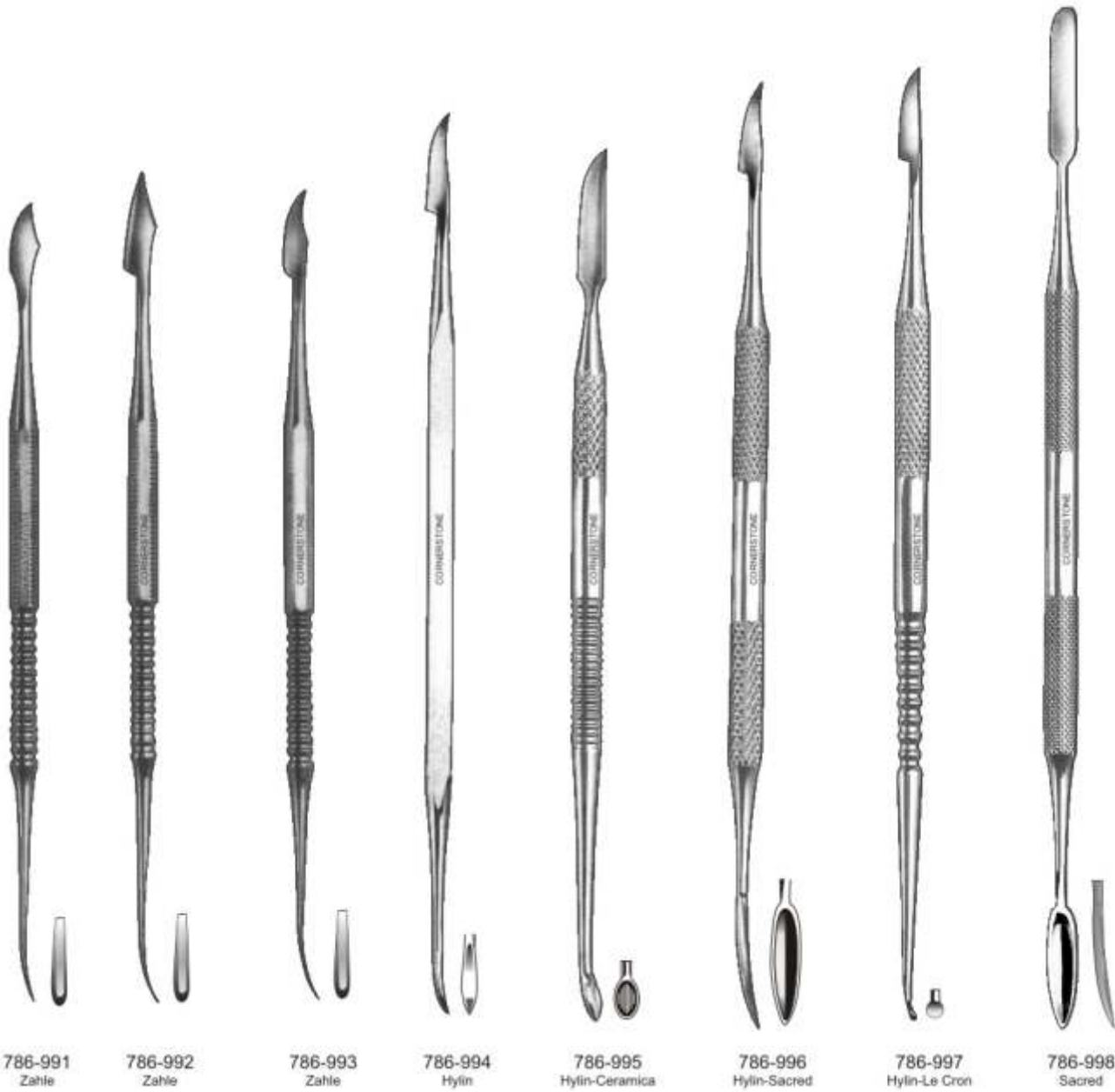

Wax and Modelling Carvers

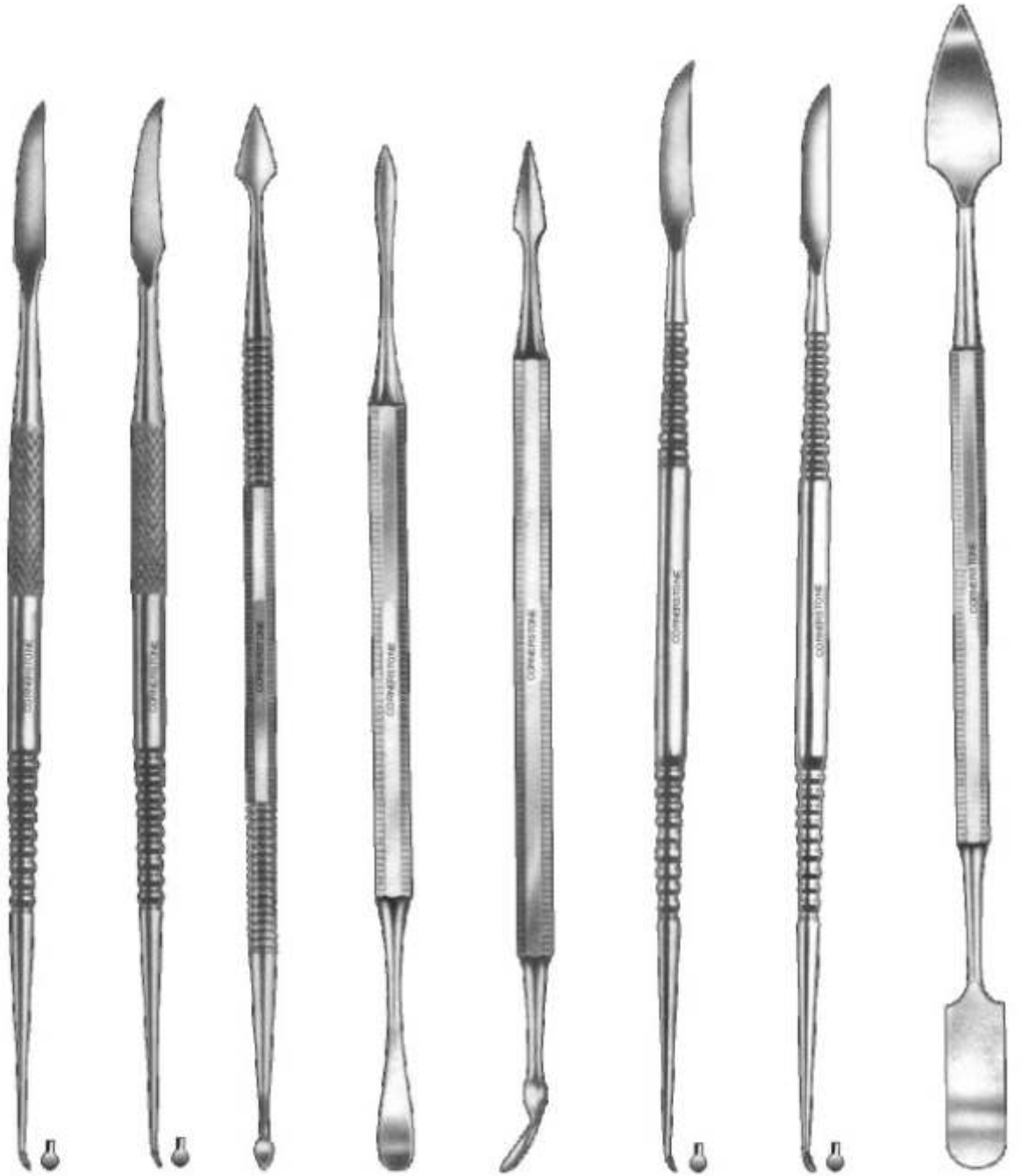

786-999  
Le Cron

786-1000  
Le Cron

786-1001  
Vehé

786-1002  
Beale

786-1003  
Roach

786-1004  
Le Cron

786-1005  
Le Cron

786-1006  
Gritman

Wax and Modelling Carvers



786-1007  
Fig.1  
P.K. Thomas



786-1008  
Fig.2  
P.K. Thomas



786-1009  
Fig.3  
P.K. Thomas



786-1010  
Fig.4  
P.K. Thomas



786-1011  
Fig.5  
P.K. Thomas



# Wax Knives

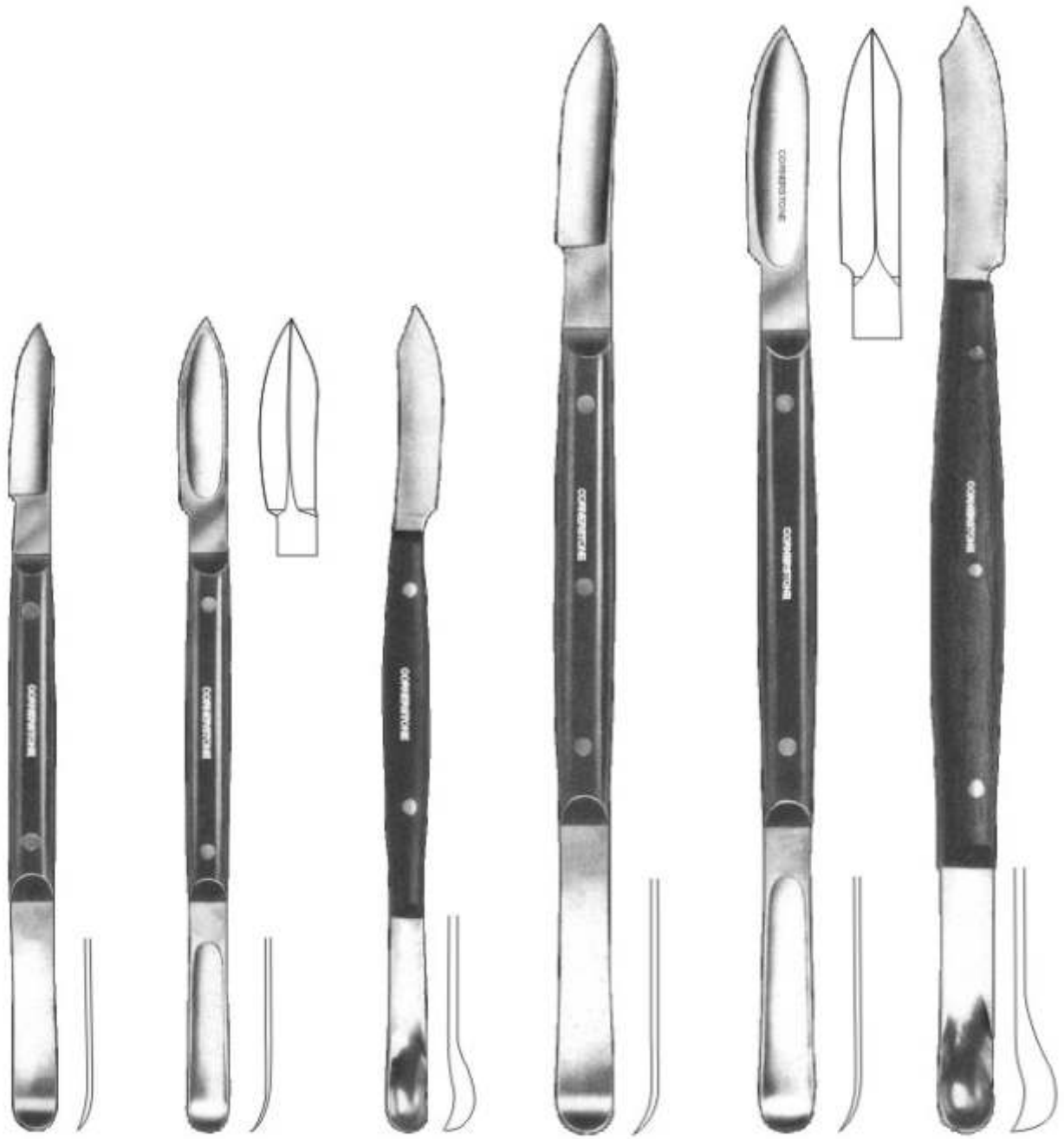

86

786-1012  
Fig.1  
Fahnenstock  
cm. 12,5

786-1013  
Fig.1  
Lessmann  
cm. 12,5

786-1014  
Fig.1  
Con Scodellino  
cm. 12,5

786-1015  
Fig.2  
Fahnenstock  
cm. 17

786-1016  
Fig.2  
Lessmann  
cm. 17

786-1017  
Fig.2  
Con Scodellino  
cm. 17

## Spatulas for Plaster and Alginate



786-1018  
cm. 17



786-1019  
cm. 17 Gritman



786-1020  
cm. 19,5

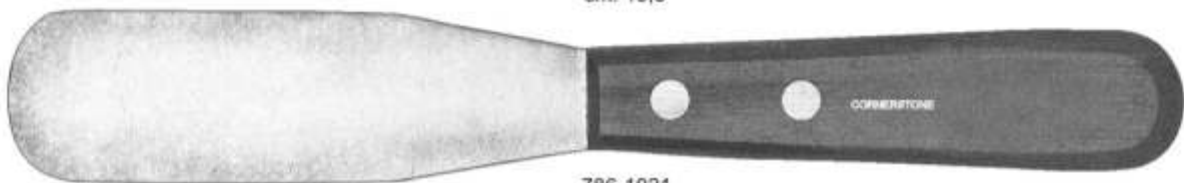

786-1021  
cm. 21,5



786-1022  
cm. 20,5



786-1023  
cm. 19,5



786-1024  
cm. 20

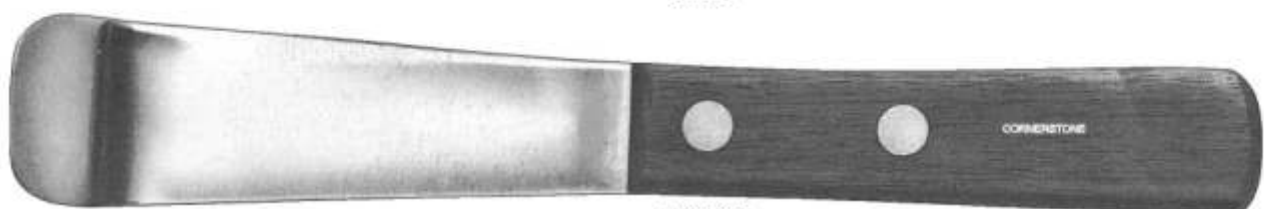

786-1025  
cm. 22,5

# Amalgam Carriers

Ø1,5 mm



786-1026  
Small

Ø2 mm



786-1027  
Medium

Ø2,5 mm



786-1028  
Large

Ø3 mm



786-1029  
Jumbo



786-1030  
Amalgam well

Ø2 mm



786-1031  
Medium /Small

Ø2 mm



786-1032  
Medium /Large

Ø2 mm



786-1033  
Medium /Jumbo

Ø1,5 mm



Ø2,5 mm



Ø3 mm



786-1034

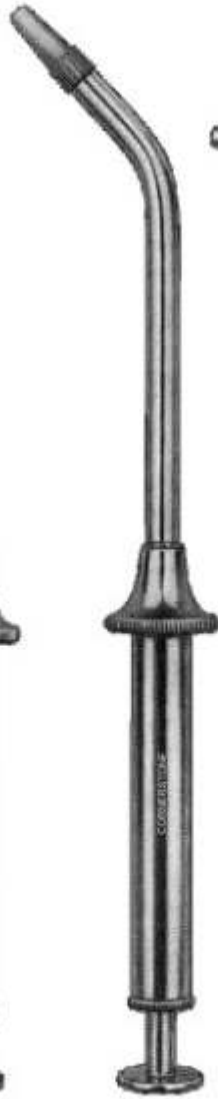

786-1035



786-1036

# Dental Cartridge Syringes



786-1037  
Intraligamentary Syringe  
1,8 ml



786-1038  
Cartridge Syringe  
2,2 ml  
1,8 ml



786-1039  
Aspirated Syringe  
1,8 ml



786-1040  
Aspirated Syringe  
1,8 ml



786-1041  
Cartridge Syringe  
1,8 ml

Available Thread:- Inches & Metric

Chip Blowers, Water Syringes  
Napkin Holder, Film Holder

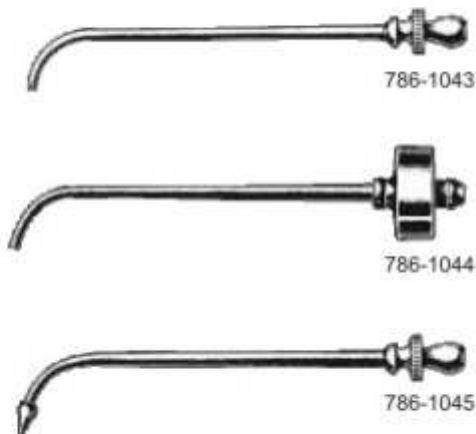

786-1043

786-1044

786-1045

786-1042  
Chip Blower



786-1046  
Film Holder for  
10 films 7866-1047  
6 films 7866-1048  
14 films

90



786-1049  
Water Syringe



786-1050  
Water Syringe



786-1051  
Napkin holder with plastic band

786-1052  
Napkin holder with metal chain

# Matrix Retainers



777-1053 - 5mm  
777-1054 - 6mm  
777-1055 - 7mm  
Ivory II



786-1056  
Ivory II N



786-1057  
Ivory II



786-1058  
Sisveland-Narrow  
786-1059  
Sisveland-Wide



786-1060  
Fig. 1  
Toffemire-Universal



786-1061  
Fig. 3  
Toffemire-Senior



786-1062  
Fig. 2  
Toffemire-junior



Adjustable

786-1063  
Fig. 2  
Didner BP



786-1064  
Ivory



With lateral shields

786-1065  
Ivory



786-1066  
Ivory  
Separator



# Crown Instruments

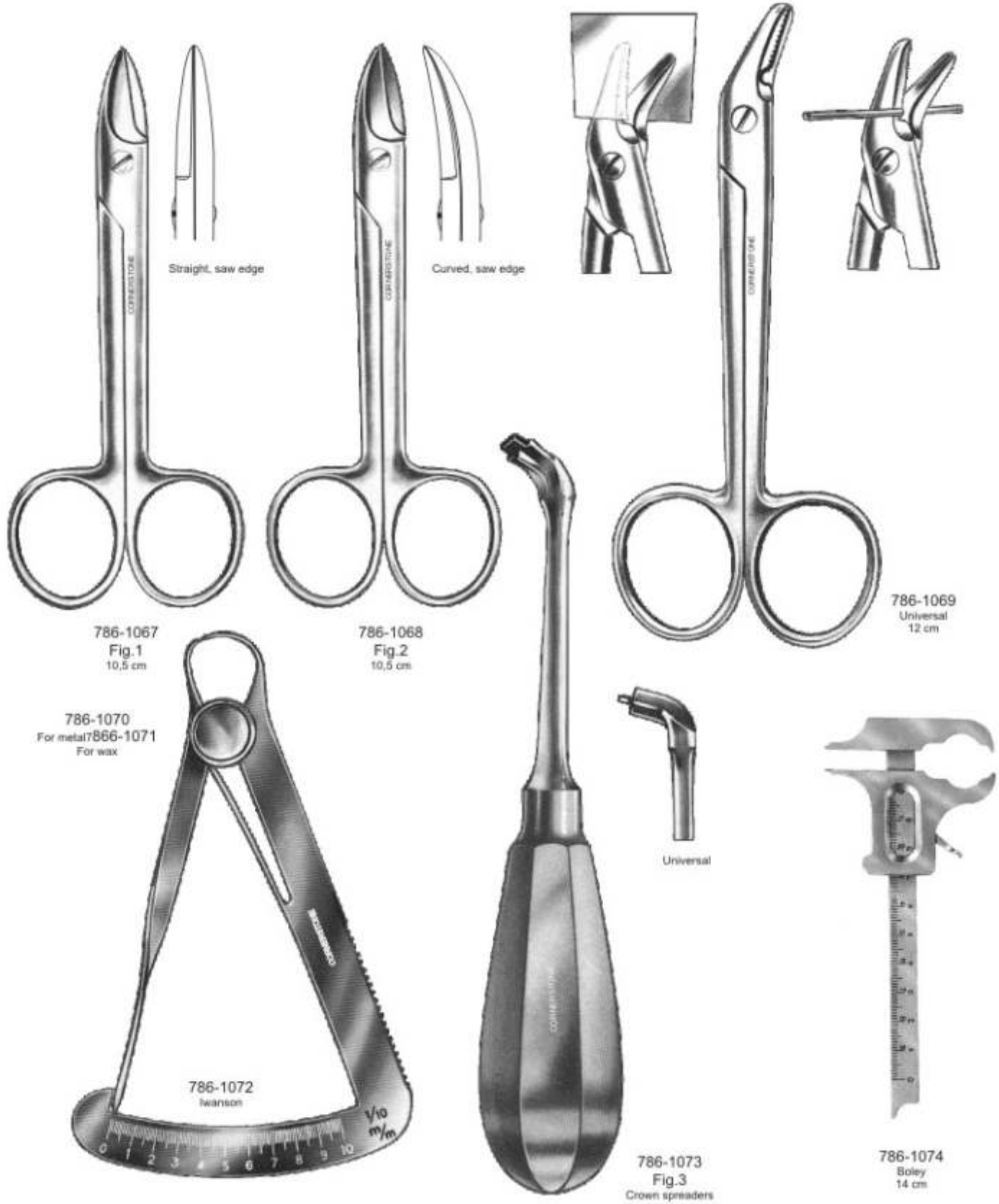

Crown Removers



786-1076  
Crown removers



786-1075  
Crown removers  
Automatic



786-1077  
Crown removers



with 5 Points



786-1078  
Crown removers



Crown Instruments  
Plaster Cutting Plier



786-1079  
15 cm

Articulating  
paper forceps



786-1080  
Miller  
15 cm



786-1081  
Crown Spreader

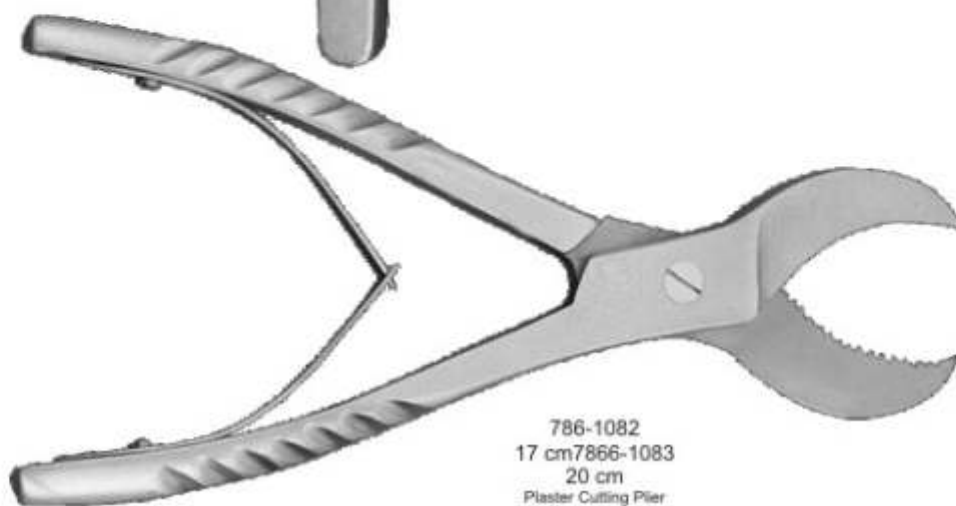

786-1082  
17 cm  
7866-1083  
20 cm  
Plaster Cutting Plier

# Stainless Steel Impression Trays

## Made of 18/8 Stainless Steel

**Solid Partial Set of 10  
225-001C**

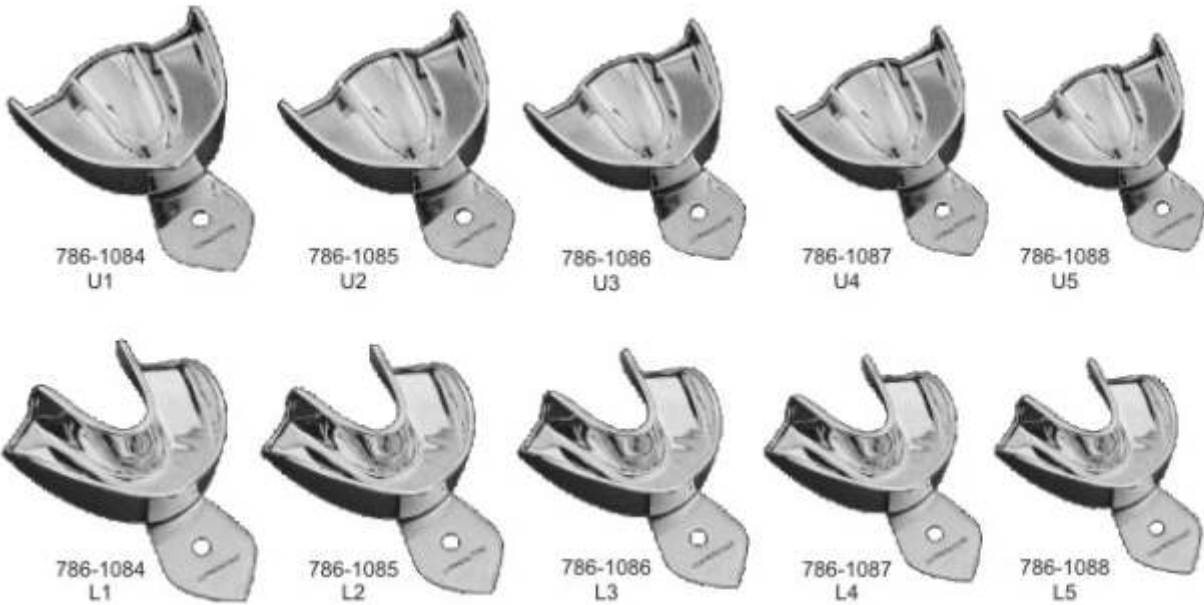

All the above impression trays are available in these 5 sizes

UPPER		U1	U2	U3	U4	U5
	A	62	60	53	54	52
B	83	75	73	69	68	

LOWER		L1	L2	L3	L4	L5
	A	63	61	57	60	53
B	82	81	78	74	71	

All Dimension are in mm

All Dimension are in mm

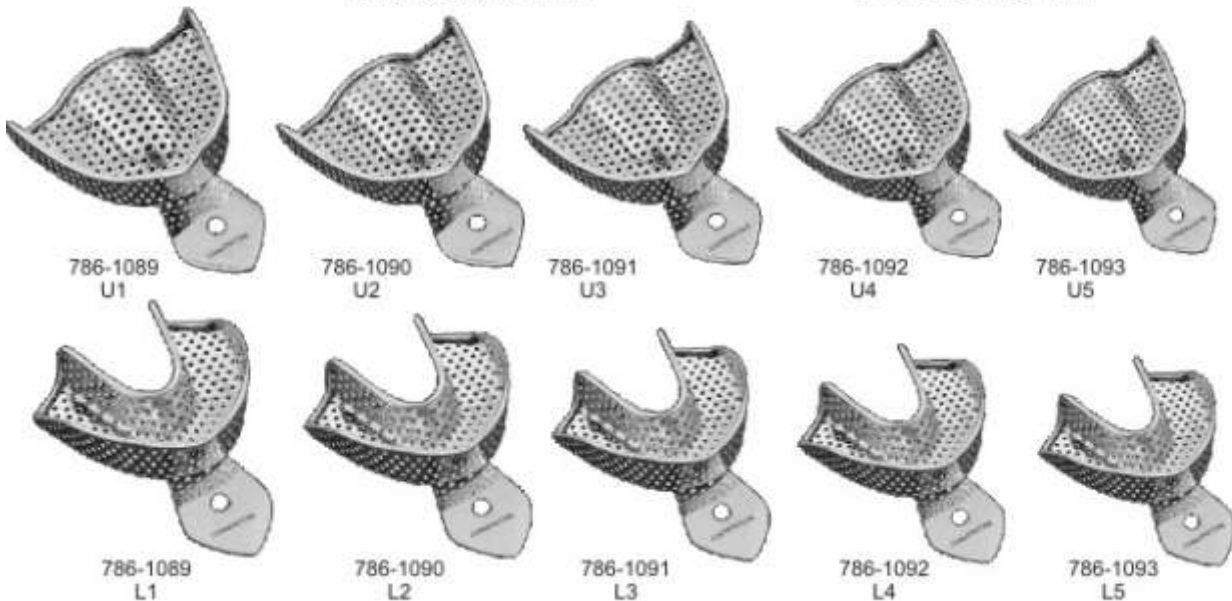

**Perforated Partial Set of 10  
225-010C**

# Stainless Steel Impression Trays Made of 18/8 Stainless Steel

**Solid Full Denture Set of 8  
225-011C**

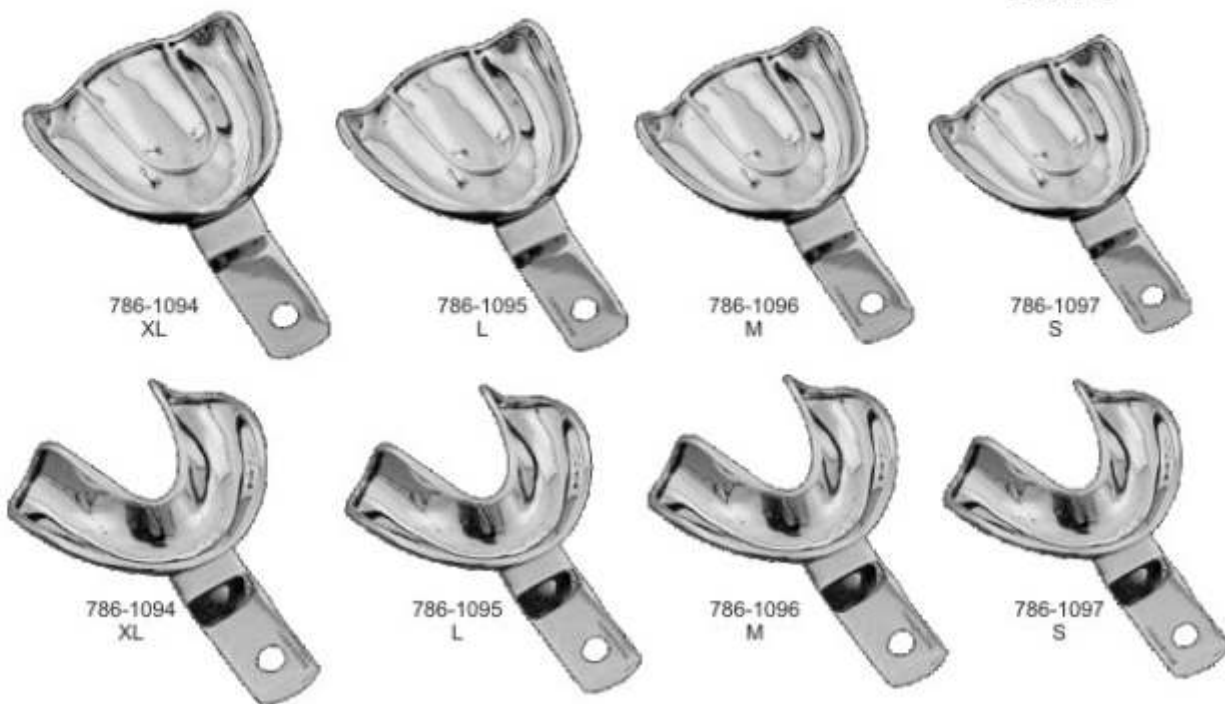

All the above impression trays are available in these 4 sizes

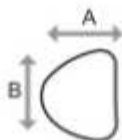

UPPER	XL	L	M	S
	A	70	67	64
B	79	76	70	73

All Dimension are in mm

LOWER	XL	L	M	S
	A	64	64	60
B	86	70	73	70

All Dimension are in mm

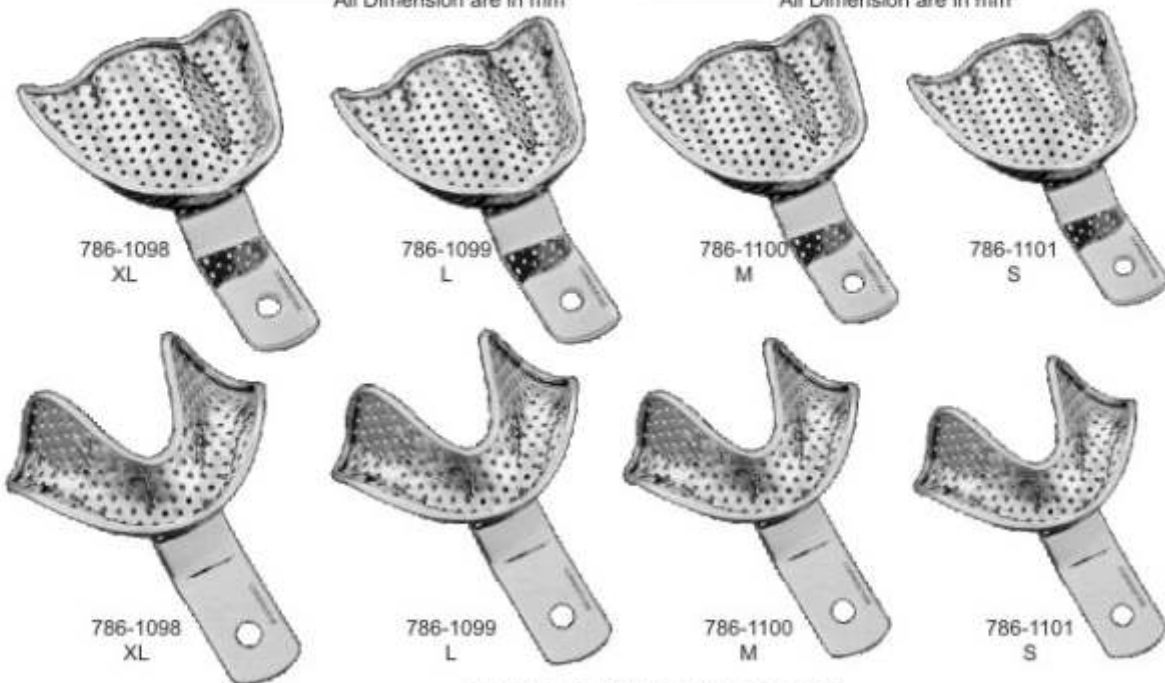
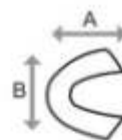

**Perforated Full Denture Set of 8  
225-018C**



# Stainless Steel Impression Trays Made of 18/8 Stainless Steel



Solid Set of 6  
225-019cs

All the above impression trays are available in these 3 sizes

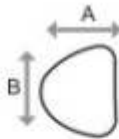

UPPER	U1	U2	U3
	A	67	64
B	81	71	70

All Dimension are in mm

LOWER	L1	L2	L3
	A	60	57
B	81	79	76

All Dimension are in mm

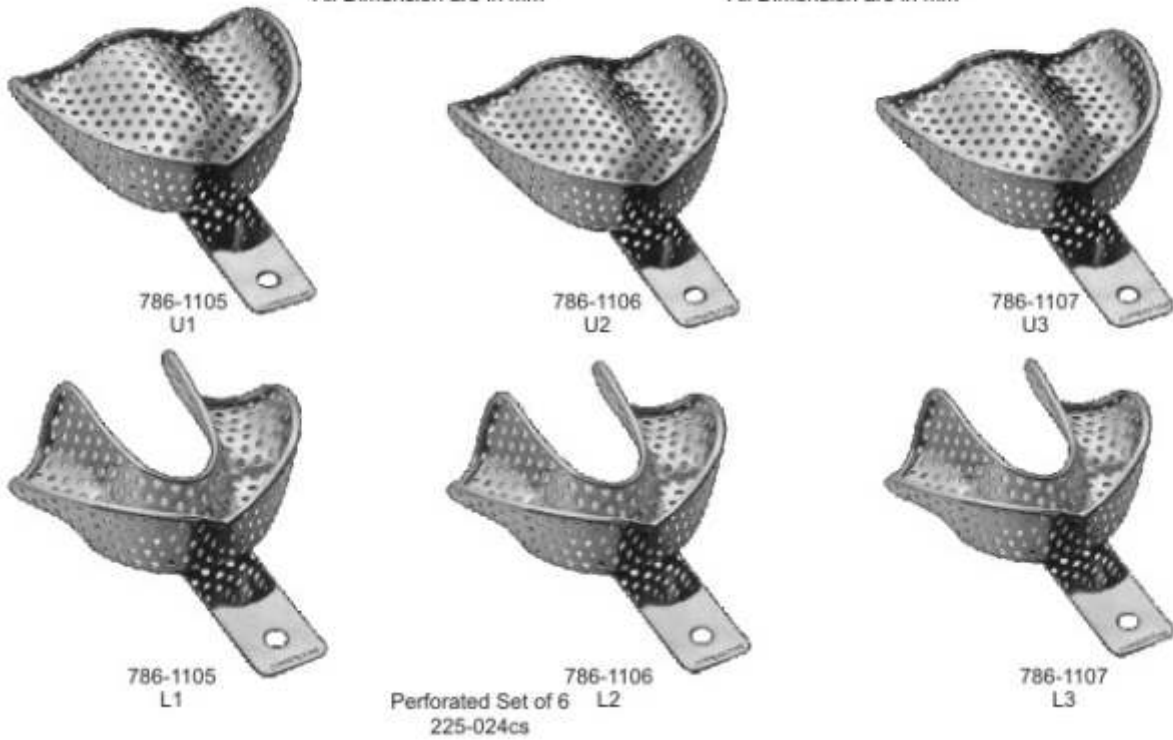
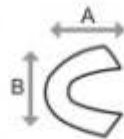

Perforated Set of 6  
225-024cs



# Stainless Steel Impression Trays Made of 18/8 Stainless Steel

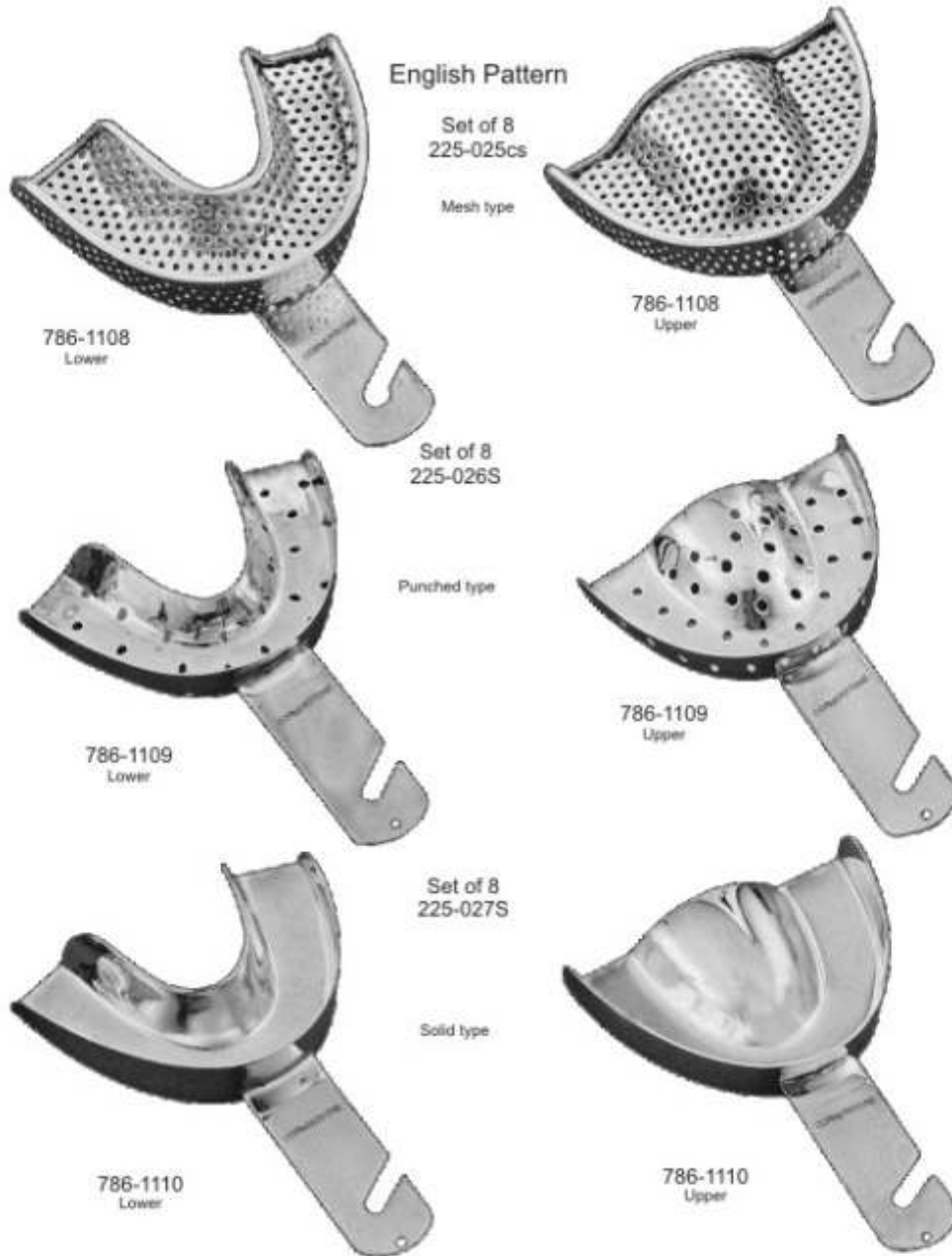

98

All the above impression trays are available in these 4 sizes

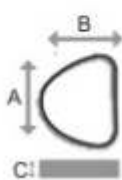

UPPER	Size	A	B	C
	0	67	50	12
	1	72	51	13
	2	78	55	15
	3	80	58	15

All Dimension are in mm

LOWER	Size	A	B	C
	0	70786	50	14
	1	79	51	15
	2	80	55	15
	3		60	17

All Dimension are in mm

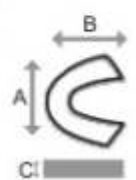

# Stainless Steel Impression Trays Made of 18/8 Stainless Steel

Solid Full Denture Set of 8  
225-028cs

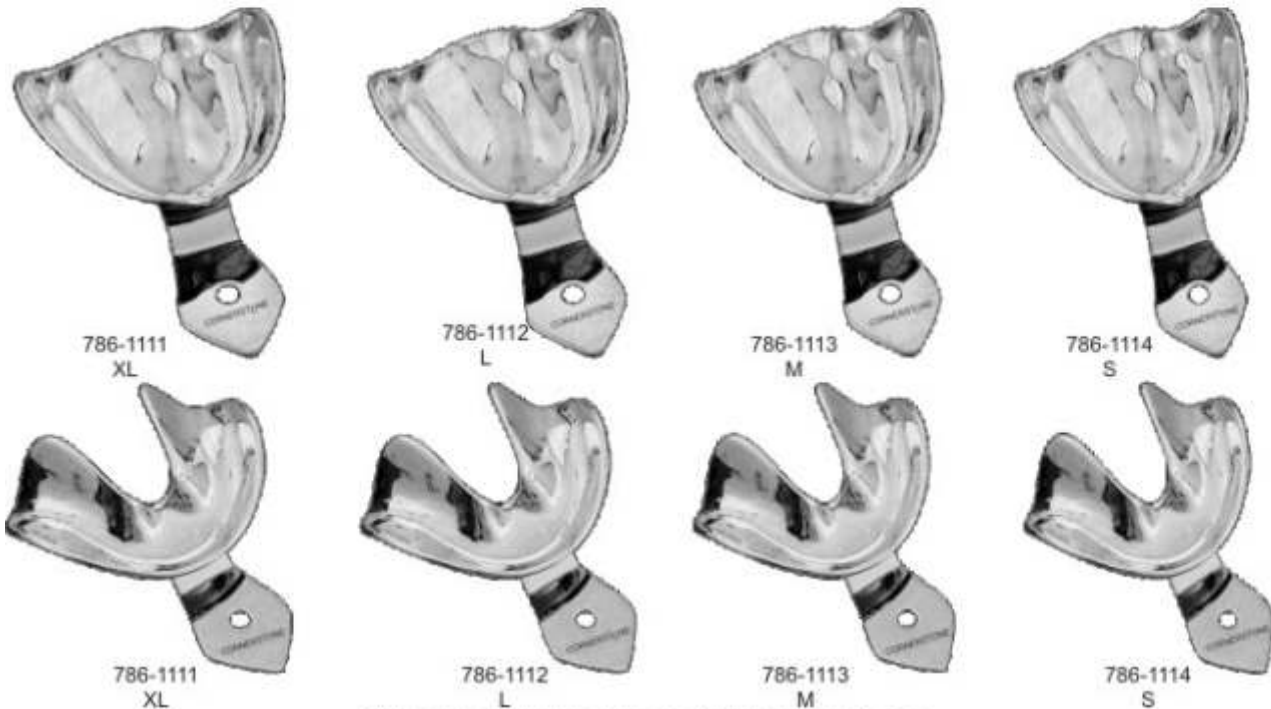

All the above impression trays are available in these 4 sizes

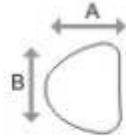

UPPER	XL	L	M	S
	A	70	67	64
B	79	76	70	73

All Dimension are in mm

LOWER	XL	L	M	S
	A	64	64	60
B	86	70	73	70

All Dimension are in mm

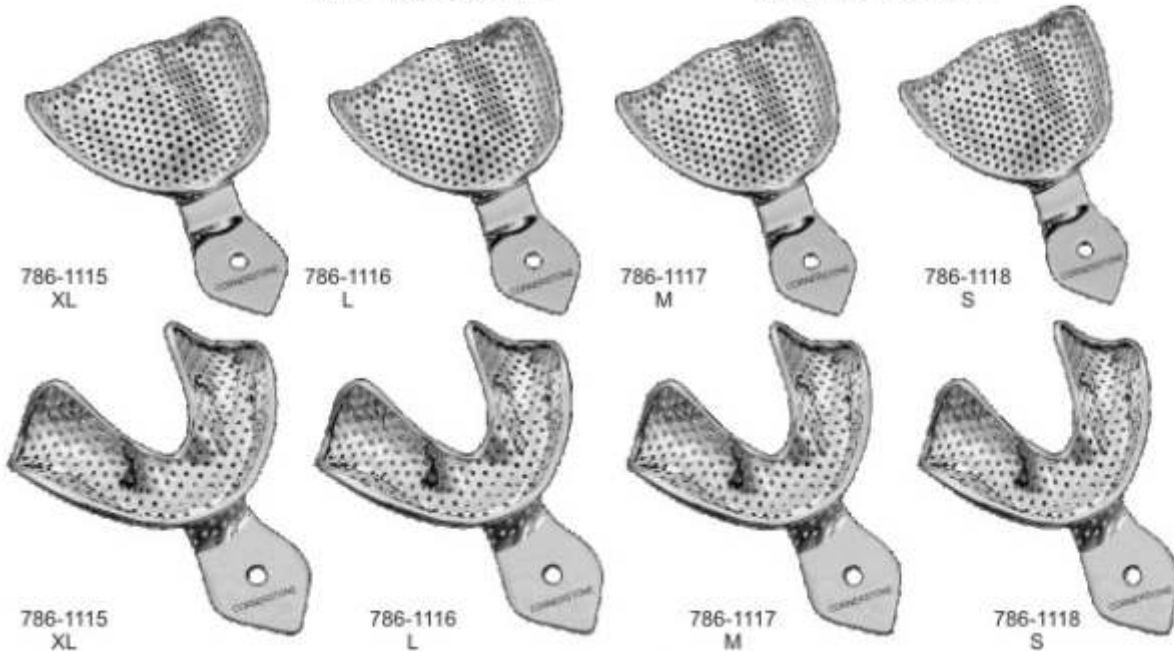
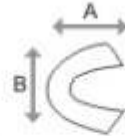

Perforated Full Denture Set of 8  
225-035cs

English Pattern  
Solid Full Denture Set of 8  
225-036cs

**Stainless Steel Impression Trays  
Made of 18/8 Stainless Steel**

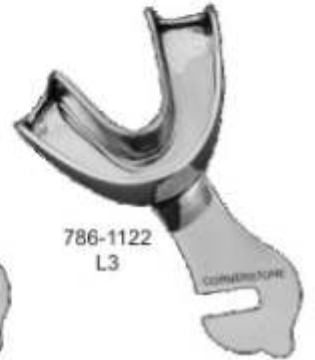

Upper Sizes 0,1,2,3,  
Depth of the tray 15,9 mm  
Height of palate 12,5 mm

Lower Sizes 0,1,2,3,  
Depth of the tray 12,9 mm

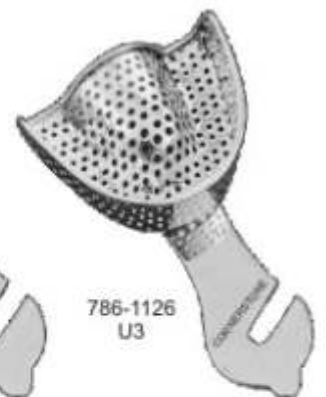
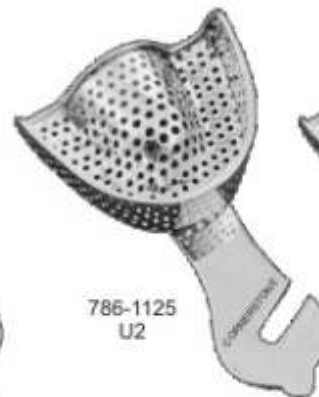
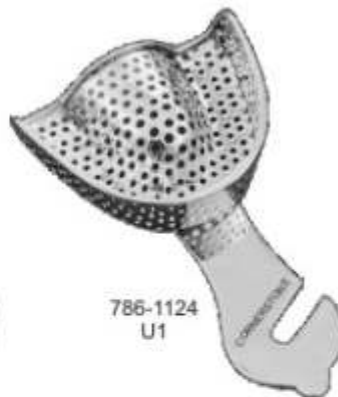

Perforated Full Denture Set of 8  
225-043cs

# Stainless Steel Impression Trays Made of 18/8 Stainless Steel

Impression trays for crown & bridge work

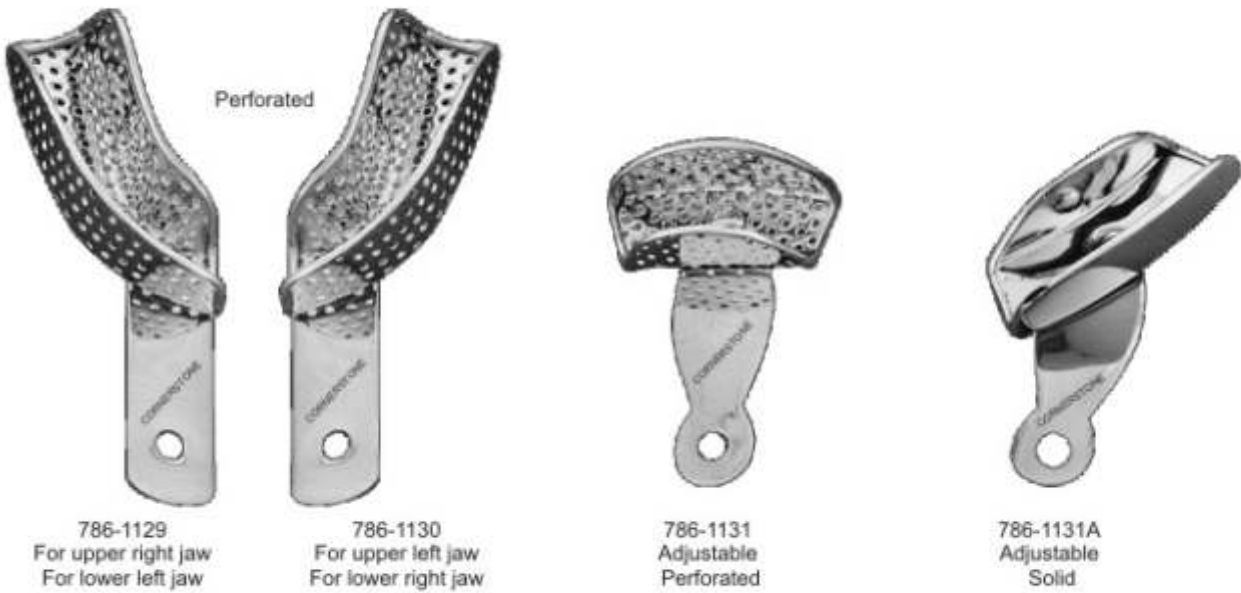
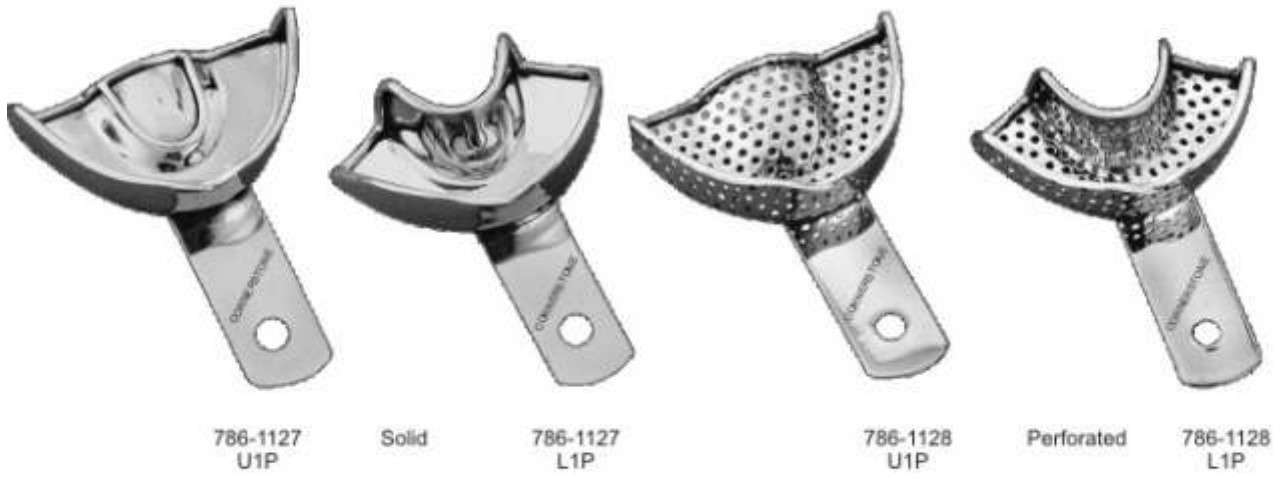

786-1129 For upper right jaw  
For lower left jaw

786-1130 For upper left jaw  
For lower right jaw

786-1131 Adjustable Perforated

786-1131A Adjustable Solid

- Available in 4 Sizes
- 1..... 44 mm
  - 2..... 55 mm
  - 3..... 60 mm
  - 4..... 65 mm

Also available in Solid pattern



# Stainless Steel Instrument Trays Made of 18/8 Stainless Steel

786-1132cs  
Complete instrument tray with perforated base,  
lid & insert frame for 16 instrument

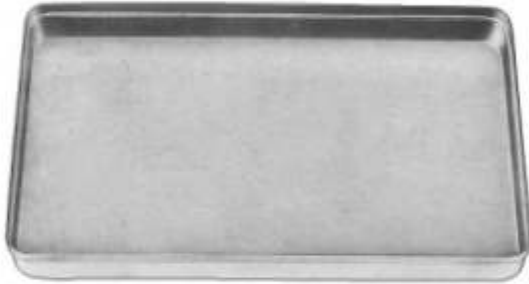

786-1132  
Lid; dimensions mm, 288x187x29

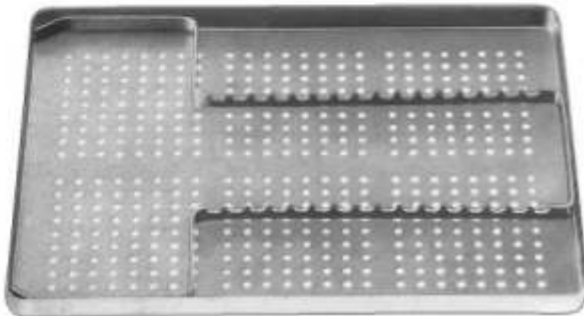

786-1133  
Perforated base; dimensions 284x183x17 mm  
786-1125cs  
Complete instrument tray with solid base,  
lid & insert frame for 16 instrument

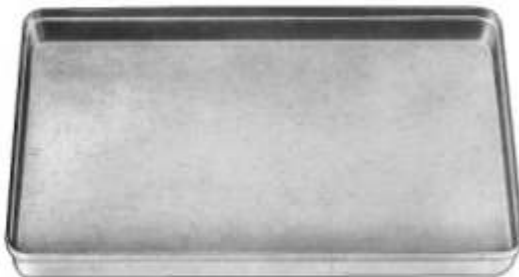

786-1134  
Lid; dimensions 288x187x29 mm

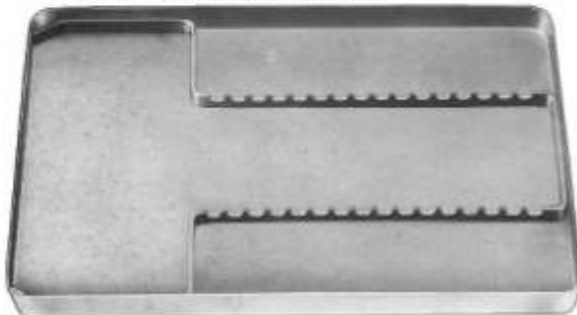

786-1135  
Solid base; dimensions 284x183x17 mm

786-1137cs  
Complete instrument tray with perforated base,  
lid & insert frame for 23 instrument

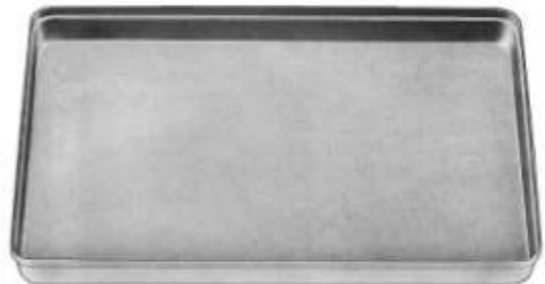

786-1136  
Lid; dimensions mm, 288x187x29

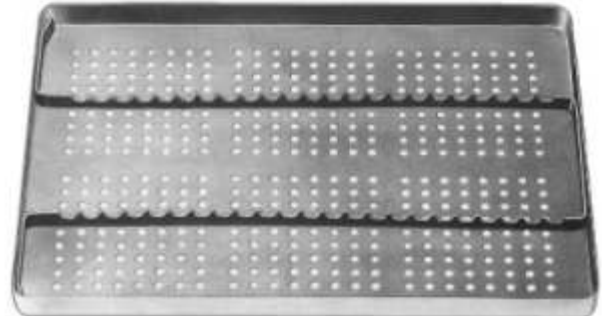

786-1137  
Perforated base; dimensions 284x183x17 mm  
786-1139cs  
Complete instrument tray with solid base,  
lid & insert frame for 23 instrument

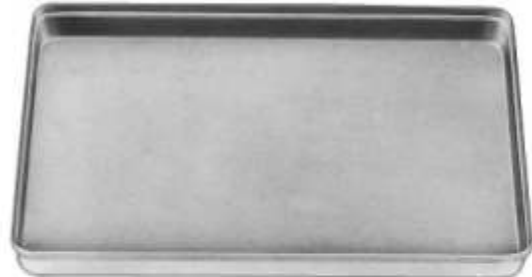

786-1138  
Lid; dimensions 288x187x29 mm

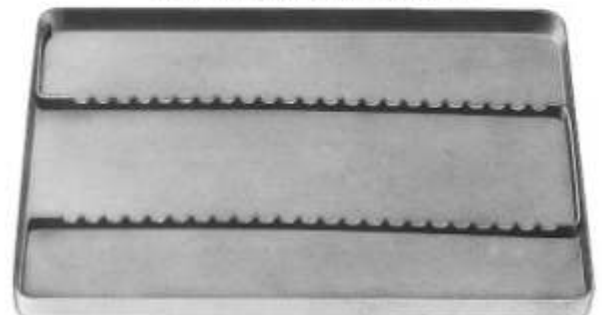

786-1139  
Solid base; dimensions 284x183x17 mm



Stainless Steel Instrument Trays  
Made of 18/8 Stainless Steel

Scalers Tray



786-1140



786-1141  
6" x 10"  
without lid



786-1142  
6" x 8"  
with lid



786-1143  
6" x 8"  
8" x 10"  
10" x 12"  
with lid



786-1144



786-1145  
Endodontic box  
Also available in Solid pattern



786-1146  
8" x 12"  
with lid

Stainless Steel Instrument Trays  
Made of 18/8 Stainless Steel



786-1147

Deep

2.25" x 2"  
4.75" x 2"  
5.5" x 2.5"  
6.25" x 2.75"  
7" x 3.5"

Kidney trays



786-1148  
12"-10"- 8"- 6"



786-1149  
6" x 9" - 8" x 12"

Shallow



786-1150  
10" x 10"

104

Round bowls



786-1151  
Cotton holder



80x35 mm  
125x60 mm

786-1152



786-1153  
Spirit lamp



786-1154  
Spirit lamp

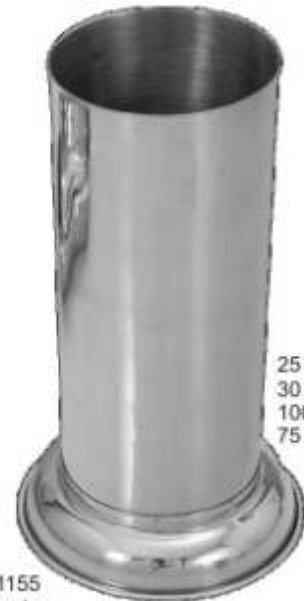

786-1155  
Forcep Jar

25 x 80 mm  
30 x 100 mm  
100 x 200 mm  
75 x 173 mm

# Rubber Dam Clamps

## Molar Clamps Winged



786-1156  
Fig. 30



786-1157  
Fig. 31



786-1158  
Fig. 51



786-1159  
Fig. 138



786-1160  
Fig. 139



786-1161  
Fig. 15



786-1162  
Fig. 18



786-1163  
Fig. 24



786-1164  
Fig. 25



786-1165  
Fig. 26



786-1166  
Fig. 28

## Bicuspid Clamps Winged



786-1167  
Fig. 206



786-1168  
Fig. 207



786-1169  
Fig. 208



786-1170  
Fig. 209



786-1171  
Fig. 22



786-1172  
Fig. 27



786-1173  
Fig. 29

## Molar Clamps Winged

## Bicuspid Clamps Winged



786-1174  
Fig. 26A



786-1175  
Fig. 28A



786-1176  
Fig. 30A



786-1177  
Fig. 31A



786-1178  
Fig. 51A



786-1179  
Fig. 27



786-1180  
Fig. 29



786-1181  
Fig. 60

## Molar Clamps Winged



786-1182  
Fig. 200



786-1183  
Fig. 201



786-1184  
Fig. 202



786-1185  
Fig. 203



786-1186  
Fig. 204



786-1187  
Fig. 205

## Labial Clamps Winged



786-1188  
Fig. 210



786-1189  
Fig. 211



786-1190  
Fig. 212

# ORTHODONTIC PLIER

## 786-005

### How Plier

Firmly hold the bracket tie wing for sealing of the band. Carbide serrated tips for non slip grip. 49.50

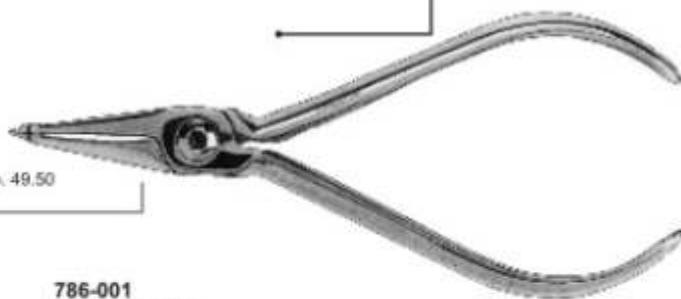

## 786-001

### De Bonding Plier

Bracket / Adhesive remover with replaceable tool steel tip. Wedge between both edges of the base of the bracket and tooth surface. Easily lifting off the bracket or Bonding material. 49.50

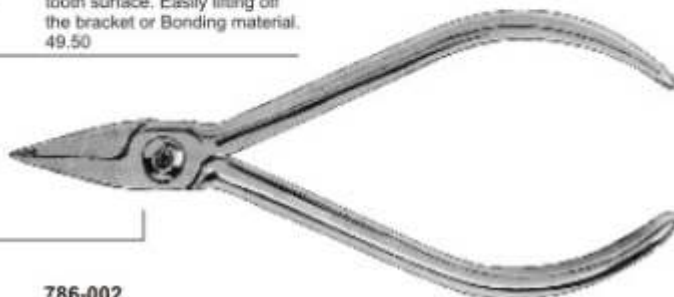

## 786-006

### Jara Back Plier

A Plier for precise bending of wires. Precision grooves ensure accurate bending and closing of loops. Serrated tip for up to .020" wires. 49.50



## 786-002

### Posterior Band Remover Long

The padded tip rest on the Occlusal of the molar and the carbide tipped side removes the bracket or Bonding material. 49.50

## 786-007

### Hard Wire Cutter

Cuts hard wire up to .020" carbide insert for longer life. 49.50

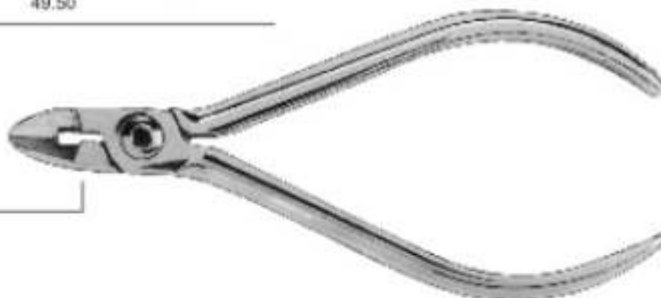

## 786-003

### Posterior Band Remover Small

49.50

## 786-008

### Pin & Ligature Cutter

Standard size lips designed to cut soft wire up to .051". 49.50

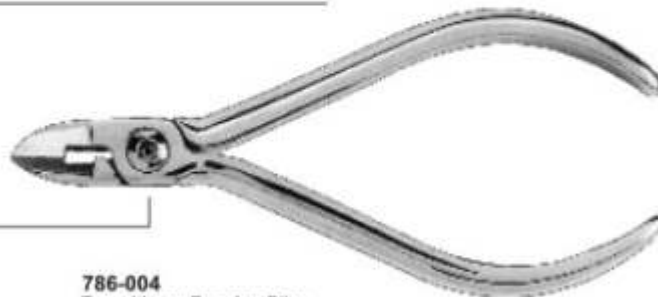

## 786-004

### Tweed Loop Forming Plier

3 Size carbide tip allows to make 3 size loops. Can hold wire firmly upto .022" x .028". The other side serrated tip gives none slip grip. 49.50



# ORTHODONTIC PLIER

**786-013**  
**Bird Beak Plier**  
 1/2" Long tip carbide inserted  
 round tip and flat ground tip  
 gives non slip grip for wire  
 up to .030". 49.50



**786-009**  
**Angled Direct Bond Bracket Remover**  
 60° Angled tip allows for easy  
 access to difficult anterior and  
 posterior areas. 49.50



**786-014**  
**Safety hold, small Distal end Cutter**  
 Narrow and light.  
 49.50

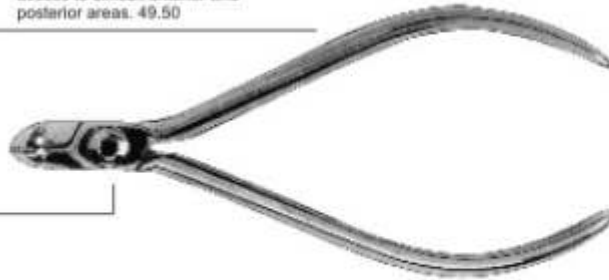

**786-010**  
**Weingart Utility Plier**  
 Matching deep serrated pads holds  
 wire firmly at a convex working  
 angle. Tapered narrow lip fits easily  
 between brackets. 49.50

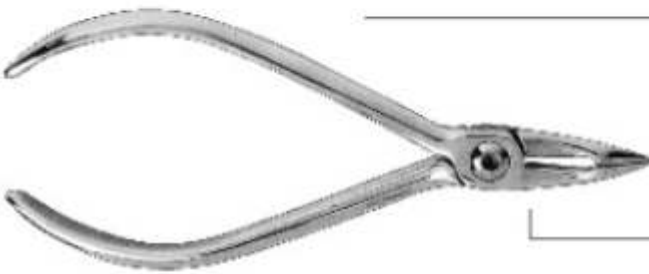

**786-015**  
**Safety hold, Distal end Cutter**  
 Carbide tips for longer life and  
 sharpness cuts and hold wire  
 up to .022" x .028". 49.50

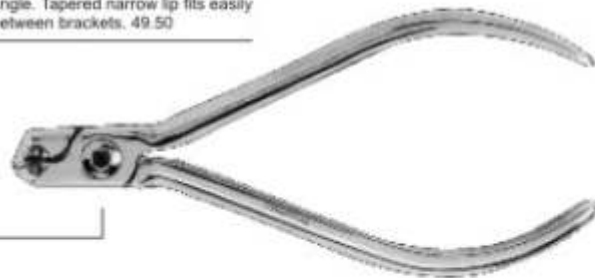

**786-011**  
**Three Prong Clasps Adjusting Plier**  
 Rounded jaws close and adjust  
 clasps without niking wire upto .030".  
 49.50

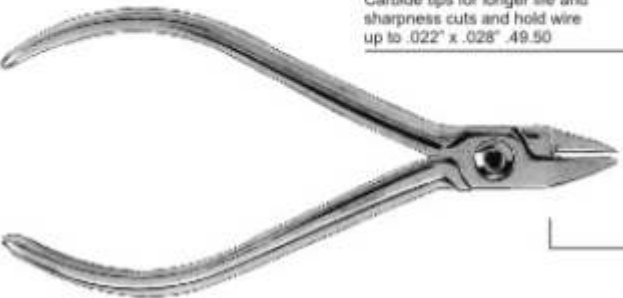

**786-016**  
**Mini Pin & Ligature Cutter**  
 Narrow tips cuts pins, Ligatures  
 and elastic smoothly and soft  
 wire up to .015". 49.50



**786-012**  
**Light Wire Plier**  
 Wire forming Plier upto .061" the  
 longer tapered beaks make it easier  
 to bend small diameter loops.  
 3Grooves on square tip. 49.50

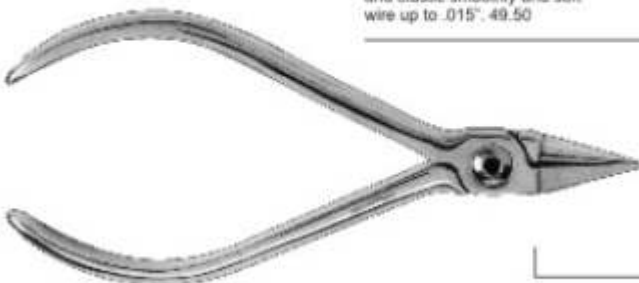



Articulators



786-3231  
Full Arch  
Chrome Plated



786-3233  
Full Denture  
Chrome Plated



786-3335  
Chrome Plated



3232  
Crowned Bridge  
Chrome Plated

108



786-3334  
Denture  
Chrome Plated



786-3336  
Full Denture  
Chrome Plated

# Soldering Tweezer



786-3216  
16cm



786-3217  
16cm



786-3218-12cm 786-3219-12cm 786-3220-12cm 786-3221-16cm



7867-3226  
16 cm



7867-3227  
16 cm



7867-3222  
10.5 cm



7867-3223  
10.5 cm



7867-3224  
16 cm



7867-3225  
16 cm

# ALPHABETICAL INDEX

## A

Aspirating Syringe	89
Arruga Needle Holder	42
Articulator	108
Apexo Root Elevator	21,22,23
Angular Scissors	34
Angle Pliers	30
Amalgam Carriers	88
Amalgam Well	88
Alm Retractors	47
Adson Forceps	53
Aderer Pliers	28,31
Adam Pliers	31

## B

Bone Ronguers	20
Bone Files	73,74
Bone Curettes	75
Boley Gauge	92
Bien Elevator	21

## C

Cryer Elevators	24
Crown Scissors	92
Crown Removers	93
Crown Instruments	92,93,94
Crane-kplane Forceps	54
Coupland Elevators	25
Cotton & Dressing Pliers	54
College Forceps	54
Columbia Curettes	77
Cleoids-Discoids	67
Chisels	51
Chip Blower	90
Cheatle Forceps	43
Cement Spatulas	82
Castroviejo Scissors	36
Castroviejo Needle Holders	42
Carvers	66,67
Cartridge Syringe	89

## D

Dressing Forceps	40
------------------	----

## E

Extracting Forceps (English Patter)	1,2,3,4,5,6,7,8 9,11,12
Extracting Forceps (Children Pattern)	10,11,13
Extracting Forceps (American Patterns)	14,15,16,17,18
Explorers	61
Excavators	69,70,71
Endodontic Box	103
Endodontic Instruments	

## F

Freer Retractor	44,45,46,47
Flohr Elevator	21
Flagg Forceps	54
Filling Instruments	62,63,64,65
Film Holder	90
Farabeuf	46

## G

Gum Scissors	34,35
Goldman-Fox Scissors	34,35
Goldman-Fox Scalars	76,79
Ggoldman-Fox Exploers	61
Greafe Retractor	44
Gracey Curettes	78
Gillies Retractor	44

## H

How Pliers	29
Hollen Back	64,66
Heidmann Spatulas	82
Heidbrink Elevator	23
Heger-Olsan Needle Holder	41
Haemostatic Forceps	38,39
Handles For Scalpel Blades	56
Handle For Reference	57
Handles For Mouth Mirror	55

## I

Iwanson Gauge	92
Ivory Retainers	91
Iris Scissors	34
Intraligmentary Syringe	89
Instruments Trays	102,103
Impression Trays	95,96,97,98,99 100,101

## J

Jaquette Curettes	80
-------------------	----

## L

Lucas Curettes	75
Locklin Scissors	35

## M

Mouth Mirror	55
Mosquito Forceps	38
Metzenbaum Scissor	37
Meriam Forceps	54
Mc Call Curettes	79
Mayo. Scissors	37
Mayo-Hegar Needle Holder	41
Matrix Retainers	91
Mathieu Needle Holders	42

## N

Neumann Scissors	36
Needle Holders	41,42
Napkin Holders	90
Nance Pliers	28

## O

Orthodontic Instruments	32,33 106,107
-------------------------	------------------

## P

Probes	59,60,61
Pliers	28,29,30,31
Plastic Filling Instruments	65,66
Plaster cutting Pliers	94
P.K.Thomas	85
Perry Forceps	54
Periodontia Probes	31
Periodontia Inst.	72,74,76,77,78,79,80,81
Peeso Pliers	30
Peau Forceps	38

## R

Rubber Dam Punch	52
Rubber Dam Frame	52
Rubber Dam Clamps Forceps	52
Rubber Dam Clamps	105
Root Elevator	21,22,23,24,25,26,27
Retractors	44,45,46,47
Raspatories	49

## S

Surgical Scissors	36
Sterlizing Drum	104
Spreader	36
Splinter Forceps	19
Spirit Lamp	104
Spencers Scissors	36
Spatulas For Plaster	87
Siqveland Wide	91
Siqveland Narrow	91
Semken-Taylor Forceps	53
Seldin Elevator	21,22,23
Scalars	80,81
Soldering Tweezer	109

## T

Tweed Pliers	31
Towner	80
Towel Forceps	43
Toffilemire	91
Tissue Pliers	53

## U

Universal Pliers	28
------------------	----

## W

Woodson	66
Wire Bending Pliers	31
Williger Retractor	48,49
Westcott Scissors	36
Wax Knife	86
Wax Carver	83,84,85
Water Syringe	90
Warwick James Elevator	27
Ward Carver	66
Waldsachs Pliers	28

## Y

Young Pliers	31
--------------	----