

Cliniklav[®] 25

For highest quality in surgical applications



MELAG



Evidence Based Sterilization

Cliniklav[®]25

The big one from MELAG –
a powerful piece of technology



For more than 50 years now, MELAG has produced high-quality sterilizers in Berlin. We have delivered 335,000 units all over the world, where they provide daily proof of quality “Made in Germany”. Over the past years we have manufactured thousands of autoclaves with fractionated pre-vacuum system and have strengthened our leading international position in this field as well.



In recent years regulations valid for autoclaves have been harmonized and standardized throughout Europe. Cliniklav[®]25 conforms to all these regulations, especially those of European Standards EN 285, EN 554, EN 556 etc. It not only fulfils but also exceeds all legal stipulations for functional safety, sterilization safety, and validation capability.



For specialized surgeons, other specialists, shared surgeries, outpatient clinics, and special wards in hospitals (e.g., for outpatient operations), the advanced Cliniklav[®]25 is just the right autoclave: not least because of its outstanding cost-benefit ratio.

Built-in printer for documenting program cycles

Electric “finger-tip” door latch with torque-controlled closing force

Easy to use: Easily legible display with plain text

Sterilization chamber made of high-quality stainless steel with massive, precision-finished sealing surface

The quadratic sterilization chamber simplifies loading and maximizes capacity. Large interior: 1StU (30 x 30 x 60 cm)

Safety door contact switch

Easy to service:
Motor-protection switch

Easily assessible: Mains fuses



Cliniklav®25 loaded with container and with MELAdem®55 installed in the sub-cabinet

Cliniklav®25 loaded with 2 trays and 1 basket

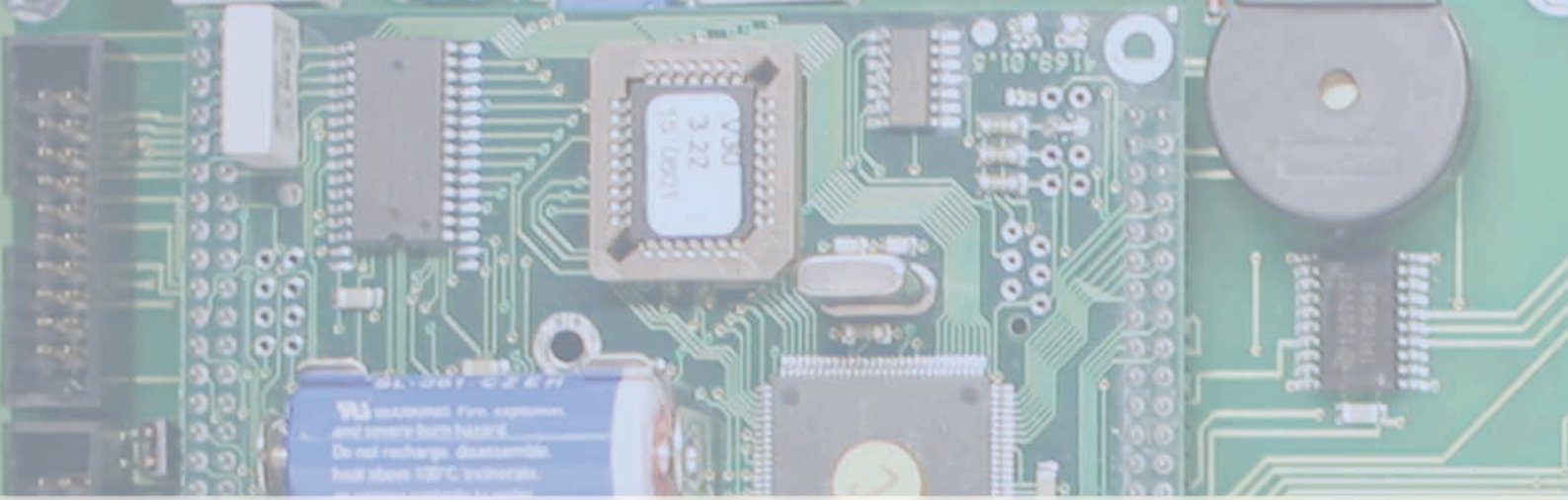

BIG PERFORMANCE – COMPACT DIMENSIONS

Quick



From the very beginning of development of the Cliniklav®25, MELAG has placed great emphasis not only on economy of power and water consumption, but also on short program run times. In addition to reduction of costs per sterilization cycle, these savings also mean that you need fewer instruments in your surgery or clinic. In other words, instruments and textiles are available again very quickly: in the Universal Program up to 15 kg of instruments are ready for use again after no more than 56 minutes (including effective vacuum drying). With the Quick Program, after only 14 min.

Reliable



It becomes really clear in a surgery how important a high-quality autoclave is when you don't have one: i. e., when you have to postpone an operation because sterile instruments, towels, aprons, etc., are just not ready. Several thousand hours of endurance tests in labs and in numerous surgeries and clinics offer you the guarantee of maximum quality and functional reliability. Close collaboration over many years with internationally acknowledged subcontractors, leading in their specialized fields, is an essential part of our successful corporate philosophy.

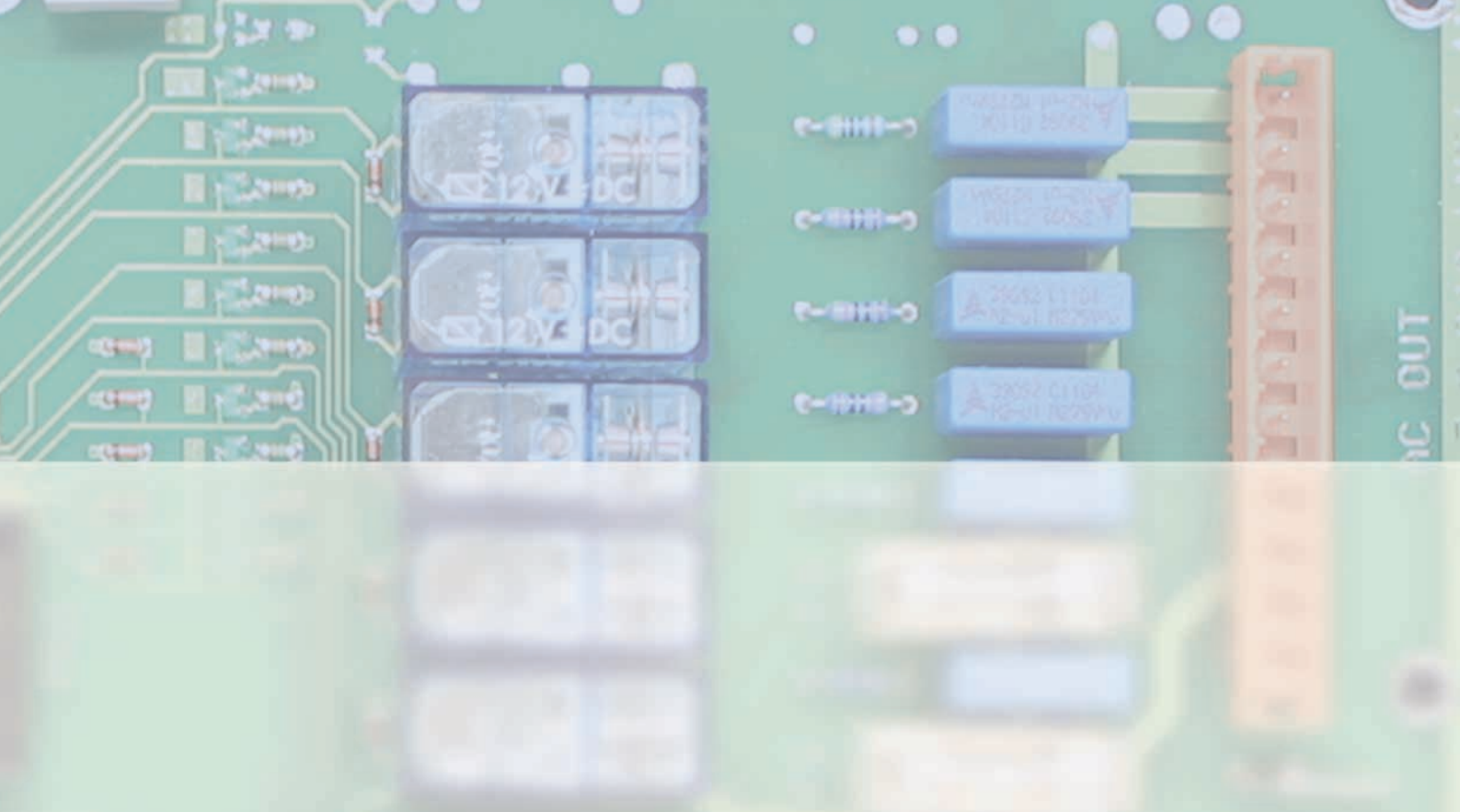

Compact, spare, and attractive



Equipment usually tends to grow fatter over the years owing to more and more special functions: although it is not always clear that they are necessary. From the very beginning of development of the Cliniklav[®]25, we made sure that its many and various functions and features, and additional convenience, did not lead to more space requirements. With its enclosure width of only 62 cm, there is room for the Cliniklav[®]25 almost everywhere: and we well know how tight things often are where things are sterilized. Even a narrow door width of only 65 cm into the room is no problem. The Cliniklav[®]25 is also available as a desktop model.

Thrifty and environmentally conscious

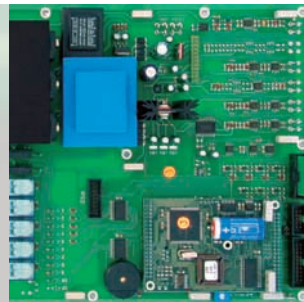

An advanced, environmentally conscious company must be committed to optimize its products under environmental aspects as well. The sophisticated conception of the Cliniklav[®]25 successfully enables a minimum of consumption of tap water (for cooling) and demineralized water (for generation of sterilization steam). We have in fact exactly coordinated the output rating of the vacuum pump (modified according to our specification) to the chamber size of the Cliniklav[®]25, and a control system feeds cooling water in accordance with the water temperature. We have also successfully minimized power consumption. The result is a highly economical and very powerful device.



Univer
r
e

SIMPLY AND DEPENDABLY EFFECTIVE

User friendliness

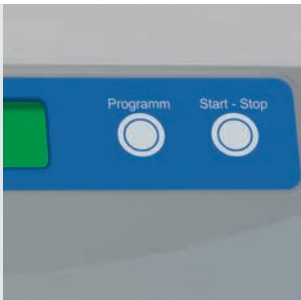

Program diversity must never become an end in itself. A great number of control elements with confusing menu selections may be optically impressive: but they can prove very expensive when they lead to the wrong program selection, aborted programs, and restarts. This all costs time and money. This is why we have limited the control elements of the Cliniklav[®]25 to only a few buttons that allow very user-friendly selection of the most important functions.

The button “Programm” selects the four sterilization programs, the Bowie & Dick test, and the vacuum test. The button “Start/Stop” starts these functions. MELAG can add individual programs to the Cliniklav[®]25, according to the user’s needs.

Dependably effective



We well know that quality is the best advertising for a product. This is why each Cliniklav[®]25 undergoes careful inspection and testing by our quality-assurance staff, during manufacture and before delivery. No autoclave leaves our plant until it achieves all stipulated parameters in all its trial runs. In addition, we log, evaluate, and archive all data in the MELAG computer centre. For us as a certified company, it goes without saying that we feel committed to guaranteeing a uniformly high level of reliability, safety, and performance. Functional effectiveness has proved the best promotion for our autoclaves.

rsal-program
successfully

Documentation with the printer



In sterilization in the clinic or surgery, the state of the art requires documentation of all measures taken against infection – and not only from liability and insurance standpoints. The MELAprint®42 printer integrated in the enclosure of the Cliniklav®25 effectively records the following data:

- The program selected
- Date, time of day, and batch number
- Actual values of pressure, temperature, and time
- Verification that the program has been successfully completed
- Any deviations or user errors that may occur.

Documentation with the PC

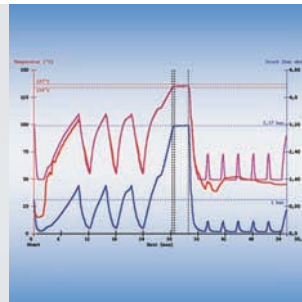

The more effective and convenient solution is to integrate sterilization documentation into the computer system already in use in your surgery or clinic. MELAG has developed its MELAwin® software for this purpose, for installation on your surgery PC (Windows®95 or later). The serial interface built into the Cliniklav®25 connects the autoclave to your PC. This configuration archives all data in the PC, instead of logging them out with the MELAprint®42. The Cliniklav®25 can additionally document the following information:

- Loading of the autoclave (e.g., instrument sets)
- The name of the current operator
- Information on the patients who are being treated with the sterilized instruments.

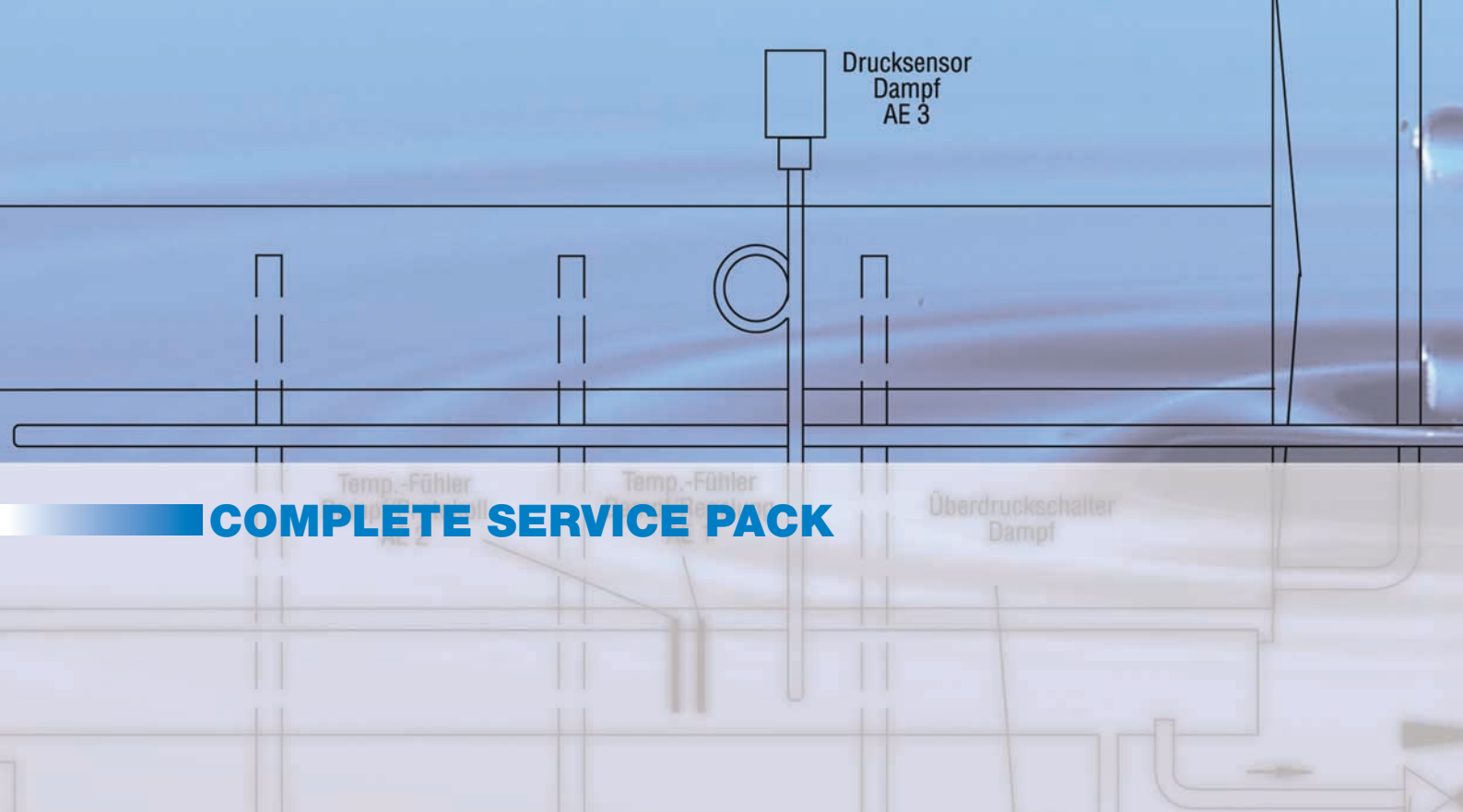

COMPLETE SERVICE PACK

First aid from the
MELAG Service Centre



Onsite service
near you

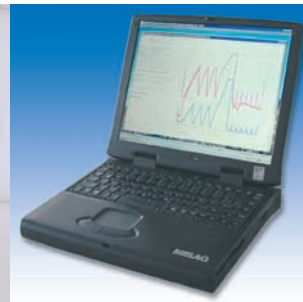

What do you do when a malfunction happens to occur? Our experience has shown that the cause is often only an operator error, or sometimes poor feed water, but seldom actually a technical fault. In all of these cases, MELAG remote diagnosis can immediately help you: an analogue modem connects your Kliniklav®25 via telephone lines with the MELAG Service Centre. A specialized MELAG engineer at a PC can immediately look into your autoclave and can perform a systematic diagnosis. He can often put your autoclave back into operation with therapy in the form of changing its internal parameters.

MELAG autoclaves are world famous for their great reliability. They are available exclusively from selected, qualified MELAG affiliates. In the selection of our business partners, we pay very special attention to the quality of the technical advice that you will receive. We also insist on the presence of qualified engineers who can provide outstanding after-sales service, in addition to effective setup of your Kliniklav®25. We regularly train these technicians. In addition, you have access to the PC-supported, MELAG English Hotline Service in Berlin, which likewise supports you in all your technical questions on the Kliniklav®25.

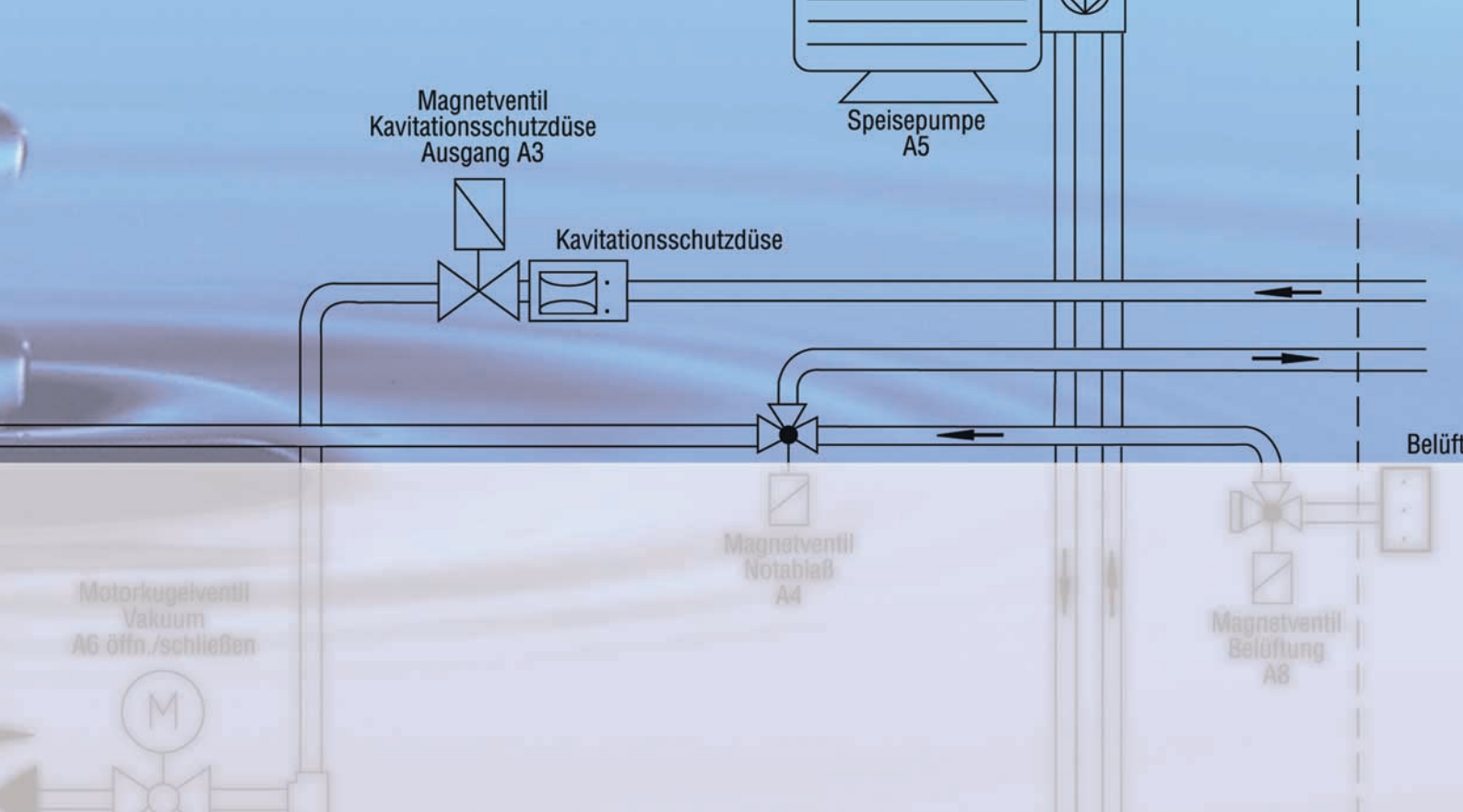

Water treatment system



MELAdem®55 is a water treatment system designed to provide high-quality demineralized water for production of steam in the Cliniklav®25. It operates according to the very environmentally friendly and cost-effective principle of reverse osmosis. The great benefit of this system is that it, unlike ion exchangers, requires no regular regeneration (harmful to the environment) for its mixed-bed resin cartridges.

With its compact external dimensions of 39 x 47 x 15 cm, the MELAdem®55 fits into the sub cabinet of the Cliniklav®25, where it allows enough room for the water-storage container and for accessories (trays, sterilization containers, etc.).

Versatile loading variations



The following accessories are available for the Cliniklav®25:

- Stainless-steel loading rack (art.-no. 2517), for:
 - Up to four aluminium trays (art.-no. 250, 59 x 30 x 5 cm), or
 - Up to two stainless-steel baskets (art.-no. 260, 57 x 27 x 13 cm),
- Stainless-steel loading rack (art.-no. 2518), for:
 - Six perforated standard tray cassettes (art.-no. 286, 29 x 19 x 4 cm),
 - Three of these racks fit into the Cliniklav®25, with the result that 18 standard tray cassettes or 18 dental trays can be sterilized at the same time.

In addition, the usual system containers (1StU, ½ StU, etc.) naturally fit into the chamber.

PROGRAM DIVERSITY

Universal program

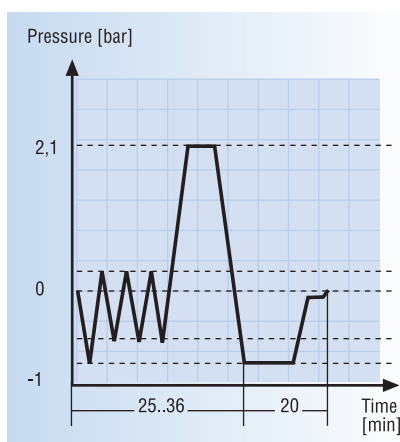

Sterilization temperature: 134 °C
 Sterilization pressure: 2.1 bar
Operating time (without drying):
 Holding time: 3.5 min
 Warm start 1 Kg instruments: 25 min
 Warm start 15 Kg instruments: 36 min
 Drying time: 20 min

Quick program

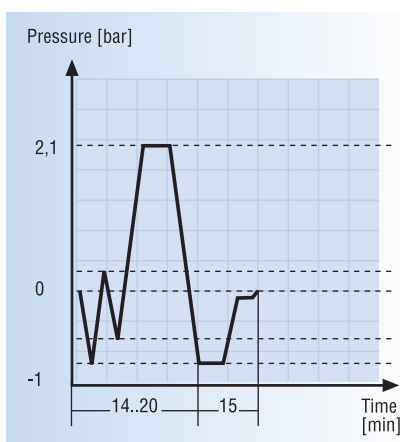

Sterilization temperature: 134 °C
 Sterilization pressure: 2.1 bar
Operating time (without drying):
 Holding time: 3.5 min
 Warm start 1 Kg instruments: 14 min
 Warm start 15 Kg instruments: 20 min
 Drying time: 15 min

Gentle program

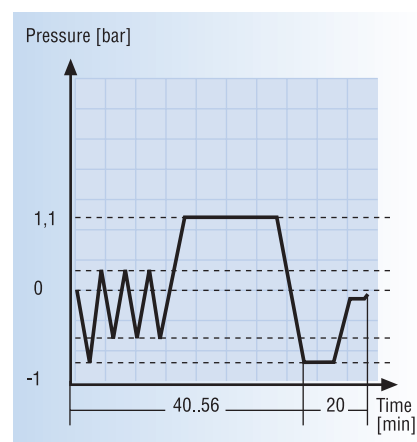

Sterilization temperature: 121 °C
 Sterilization pressure: 1.1 bar
Operating time (without drying):
 Holding time: 16 min
 Warm start 1 Kg textiles: 40 min
 Warm start 7 Kg textiles: 56 min
 Drying time: 20 min

Prion program

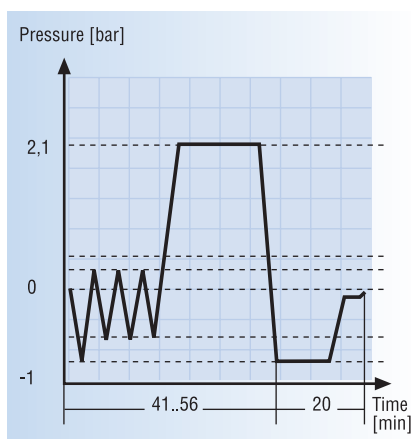

Sterilization temperature: 134 °C
 Sterilization pressure: 2.1 bar
Operating time (without drying):
 Holding time: 20 min
 Warm start 1 Kg instruments: 41 min
 Warm start 15 Kg instruments: 56 min
 Drying time: 20 min

Bowie&Dick test

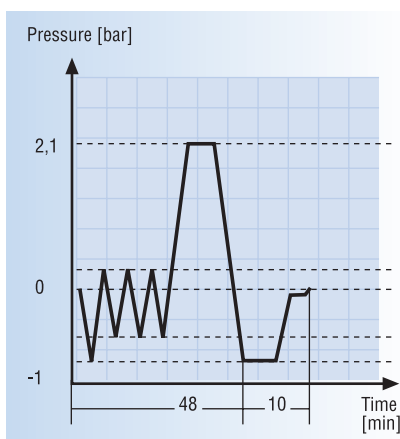

Sterilization temperature: 134 °C
 Sterilization pressure: 2.1 bar
Operating time (without drying):
 Holding time: 3.5 min
 Warm start
 Standard test package 7 Kg: 48 min
 Drying time: 10 min

Vacuum test

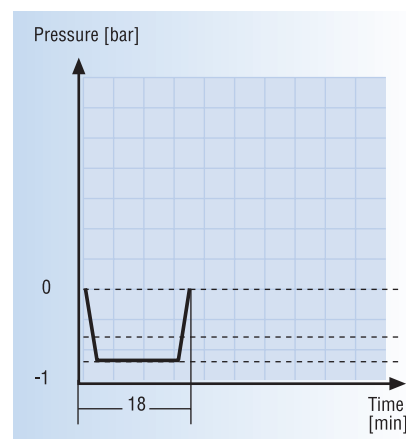

Operating time
 Chamber without any load: 18 min

TECHNICAL DATA/INSTALLATION

Components included:

- Door latch powered by electric motor, controlled by pushbutton
- Electric door locking
- Redundant process monitoring, independent of control system
- Absolute-pressure sensor for control, independent of fluctuations in atmospheric pressure
- PT 1000 sensor for exact control and monitoring of temperature
- Economical water-ring vacuum pump
- Powerful steam generator with 9-kW output
- Serial interface (RS 232) to connect the MELAprint®42 printer or a PC

Installation by the user/ requirements

- Connection of the Cliniklav®25 is very simple, similar to that of a washing machine
- DN 15 cold-water line, with flow pressure at least 2.5 bar (also applies for additional connection of the MELAdem®55)
- Water drain either by a DN 40 wall connection (with MELAG Water Stop Valve, art.-no. 1056, or by a DN 40 floor drain
- Power connection: 3 N AC 400 V/50-60 Hz, with 3 x 16 A fuse protection, with power rating max. = 10 kW
- Area required for installation: 62 cm wide x 84 cm deep

Dimensions

	Depth	Width	Height	Weight
Desktop model	84.0 cm	61.6 cm	80.0 cm	157 kg
Desktop model with sub cabinet	84.0 cm	61.6 cm	149.6 cm	197 kg
Chamber volume	65.0 cm	32.0 cm	32.0 cm	

Consumption of tap water (for cooling) and demineralized water (for steam generation)

	Unwrapped instruments	Wrapped instruments	Textiles
Consumption of aqua-dem	2.0 – 3.0 l	3.0 – 3.6 l	3.6 – 4.5 l
Consumption of cooling water (without drying)	6.0 – 9.0 l	8.0 – 12.0 l	15.0 – 30.0 l
Consumption of cooling water (with drying)	9.0 – 16.0 l	32.0 – 36.0 l	35.0 – 60.0 l

Average power consumption:

	Quick program	Universal program	Gentle program
Load of 1 kg to 15 kg instruments	1.5 – 1.8 kWh	2.3 – 2.9 kWh	--
Loads of 1 kg to 7 kg textiles	--	--	2.6 – 3.5 kWh



Quality und precision for most exacting hygienic requirements

In order to exercise the professional care and diligence due in the medical professions, it is essential to implement reliable and effective hygienic measures to protect patients and medical staff. It is of course the responsibility of industry to provide the equipment and processes required for these purposes. More than 50 years ago, MELAG began in Berlin to specialize in the manufacture of sterilization equipment. As a result of high-level quality consciousness, reliability, and innovative eagerness – together with the highest in safety objectives – the family-run enterprise MELAG has succeeded in becoming a leading producers of sterilization equipment. Verification of this success has been the sale of more than 335,000 MELAG units around the world. Decades of expe-

rience, modern computer-aided production technology in application on over 7,000 sq. metres of production floor, the employment of highest-quality materials, and an experienced and reliable staff – all these have made MELAG equipment renowned for its quality and convenience of operation. MELAG corporate policy includes systematic specialization in a limited line of products. In this way it is possible for MELAG as a successful medium-size business to employ its highly specialized development team to effectively satisfy market demands and to further develop the MELAG line of products on a leading international level. The entire MELAG staff is proud to have made an important contribution to the protection of the health of patients and of medical staff, with the equipment and accessories it produces for reliable sterilization and safe storage of sterilized articles.

www.melag.com

**Quality –
made in Germany**